

LABORATORY

Microscopes

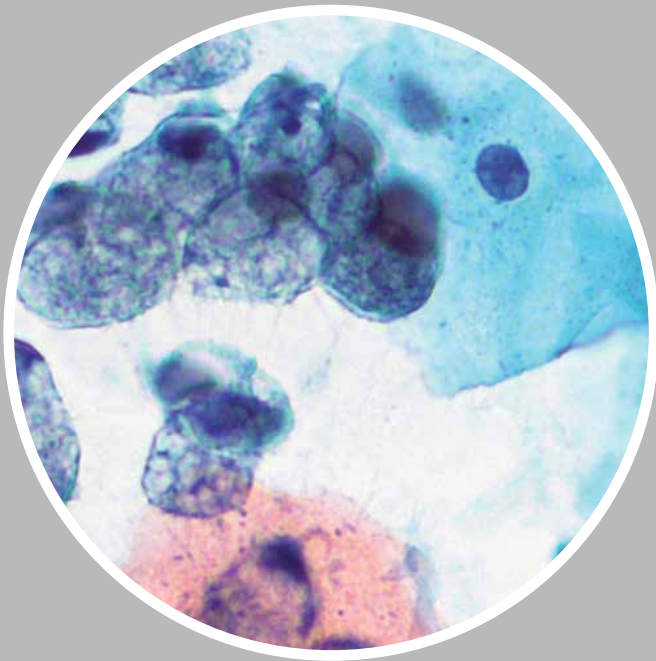





























- [B-380 SERIES - Upright laboratory microscopes](#) page 69
- [B-500 SERIES - High quality upright laboratory microscopes](#) page 77
- [B-800 SERIES - Research microscopes](#) page 87
- [B-1000 SERIES - Modular research microscopes](#) page 93
- [POL SERIES - Laboratory & research polarizing microscopes](#) page 113
- [FLUO SERIES - Upright and inverted epi-fluorescence microscopes](#) page 123
- [XDS SERIES - Inverted biological microscopes](#) page 141



Icons

	Monocular		Magnification 400X		X-LED ² illuminator
	Binocular		Magnification 1000X		X-LED ³ illuminator
	Trinocular		Incident light		X-LED ⁸ illuminator
	Field number 16		Transmitted light		1W LED illuminator
	Field number 18		Polarized light		LED illuminator
	Field number 20		Halogen lamp		Automatic light control
	Field number 22		incandescent lamp		Infinity-corrected optics
	Field number 24		Dichroic lamp		Rechargeable battery
	Rotating head 360°		USB connection		Anti-fungus treatment

B-380 Series

Upright laboratory microscopes



B-380 Series

Revolutionary - Reliable

Your routine work requires long hours on your microscope.

Easily accessible controls, including the stage drive, fine focus and brightness control combined with Optika's revolutionary ALC system grants maximum comfort and relaxed working conditions.

Standard version

- B-382PL-ALC** Binocular microscope, E-PLAN objectives , with **Automatic Light Control**.
- B-383PL** Trinocular microscope, E-PLAN objectives.
- B-382PLi-ALC** Binocular microscope, E-PLAN IOS objectives , with **Automatic Light Control**.
- B-383PLi** Trinocular microscope, E-PLAN IOS objectives.
- B-382PH-ALC** Binocular phase contrast microscope, PLAN objectives , with **Automatic Light Control**.
- B-383PH** Trinocular phase contrast microscope, PLAN objectives.
- B-382PHi-ALC** Binocular phase contrast microscope, PLAN IOS objectives , with **Automatic Light Control**.
- B-383PHi** Trinocular phase contrast microscope, PLAN IOS objectives.

Special version

- B-383POL** Trinocular polarizing microscope, E-PLAN IOS objectives. (Information in **POL SERIES**)
- B-383MET** Trinocular metallurgical microscope, PLAN IOS MET obj. , X-LED incident & transmitted illumination. (Information in **INDUSTRY SERIES**)
- B-383FL** Trinocular HBO fluorescence microscope, E-PLAN IOS objectives, B&G filtersets. (Information in **FLUO SERIES**)
- B-383LD1** Trinocular LED fluorescence microscope, E-PLAN IOS objectives, B filterset. (Information in **FLUO SERIES**)
- B-383LD2** Trinocular LED fluorescence microscope, E-PLAN IOS objectives, B&G filtersets. (Information in **FLUO SERIES**)
- B-383DK** Trinocular darkfield microscope, E-PLAN objectives, for blood analysis.



B-380 Series

Your dedicated routine microscope

B-383PHi

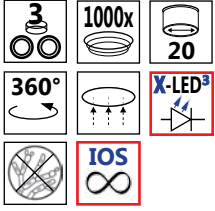

Optical system & objectives

The models of the B-380 series are equipped, depending on the various models, with two different types of optical system: the standard 160mm one and the infinity corrected system (IOS). In both cases the field diameter of the eye-pieces is 20mm.

Microscope stand

Modern and ergonomic, this stand is made of die-cast aluminium. Coarse and fine focusing (graduation: 0.002mm) with coaxial control knobs.

Adjustable focusing tension and limit stop.

Head

Available in binocular or trinocular version.

The heads are equipped with interpupillary distance control (55-75 mm) as well as with dioptic compensation.

All heads are 30° inclined.

Illumination

The illuminating system consists of X-LED³ source.

The brightness can be adjusted by a rheostat located on the left side of the microscope base.

Stage

Innovative belt drive system

Design

New ergonomic design

X-LED³ - The future of illumination

OPTIKA is proud to introduce its own revolutionary LED powered illumination system. Developed by our R&D dept. it consists of a new combination of LED and optical technology.

A new high-efficiency single chip LED works in combination with a special optical lens, which allows to double the intensity of the light generated by the LED itself. The result is a quantity of light equivalent to the light generated by a standard 50W halogen bulb, but with a colour temperature of 6300K. It means white light instead of the yellow one produced by halogen bulbs.

The electrical consumption (3.6W only) shows the high efficiency of the system: same light intensity with less than 10% of the consumption of a standard halogen bulb. Last but not least, the lifetime of our LED is 50.000 hours, instead of 1.500 hours ...!



Real picture taken from B-383PHi with 100x objective without immersion oil

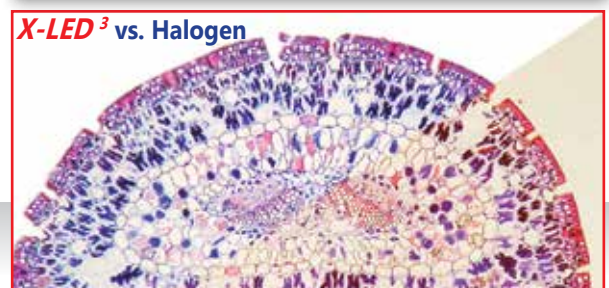

X-LED³ vs. Halogen

B-380 Series - Models



B-382PL-ALC

2	1000x	20
	X-LED ³	

ALC - Automatic light control

The level of light is adjusted by the microscope in order to maintain the same level as the one the user has chosen, no matter if the aperture of the diaphragm changes, another objective is inserted, opacity of the sample changes, etc.

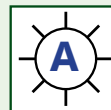

B-383FL

3	1000x	20
360°		X-LED ³
		IOS

More information in
FLUO SERIES

B-380 Series - Models

B-383MET

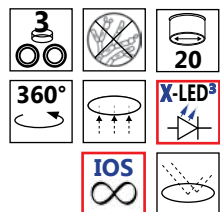

More information in
INDUSTRY SERIES



B-383POL

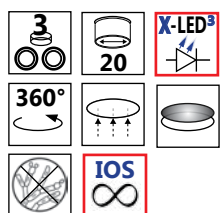

More information in
POL SERIES



B-380 Series - Models



B-383LD1

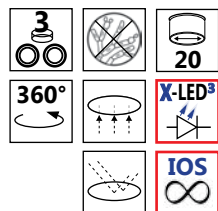

More information in
FLUO SERIES

B-383DK

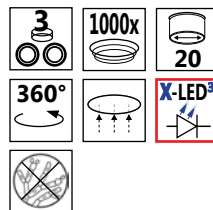

B-383LD2

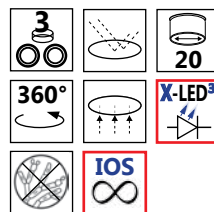

More information in
FLUO SERIES

B-380 Series - Technical specifications

Model	Head	Eyepiece	Objectives	Nosepiece	Stage	Focusing	Condenser	Illuminator	Power supply
B-382PL-ALC	Binocular 30° inclined	Wide Field 10X/20 mm	E-PLAN 4x, 10x, 40x, 100x (oil)	Quintuple nosepiece, reversed	Double layer mechanical sliding stage, 160x140mm, moving range 78x54mm	Coaxial coarse and fine focusing with limit stop	Abbe condenser, sliding-in, N.A. 1.25 with centering system	X-LED ³ , with Automatic Light Control	External power supply: Input 100-240Vac 50-60Hz. Output 6Vdc 1A
B-383PL	Trinocular 360°rotating 30° inclined	Wide Field 10X/20 mm	E-PLAN 4x, 10x, 40x, 100x (oil)	Quintuple nosepiece, reversed	Double layer mechanical sliding stage, 160x140mm, moving range 78x54mm	Coaxial coarse and fine focusing with limit stop	Abbe condenser, sliding-in, N.A. 1.25 with cente- ring system.	X-LED ³ , with manual brightness control	External power supply: Input 100-240Vac 50-60Hz. Output 6Vdc 1A
B-382PLi-ALC	Binocular 30° inclined	Wide Field 10X/20 mm	IOS E-PLAN 4x, 10x, 40x, 100x (oil)	Quintuple nosepiece, reversed	Double layer mechanical sliding stage, 216x150mm, moving range 78x54mm, Belt-drive in X direction	Coaxial coarse and fine focusing with limit stop	Abbe condenser, sliding-in, N.A. 1.25 with centering system.	X-LED ³ , with Automatic Light Control	External power supply: Input 100-240Vac 50-60Hz. Output 6Vdc 1A
B-383PLi	Trinocular 360°rotating 30° inclined	Wide Field 10X/20 mm	IOS E-PLAN 4x, 10x, 40x, 100x (oil)	Quintuple nosepiece, reversed	Double layer mechanical sliding stage, 216x150mm, moving range 78x54mm, Belt-drive in X direction	Coaxial coarse and fine focusing with limit stop	Abbe condenser, sliding-in, N.A. 1.25 with centering system.	X-LED ³ , with manual brightness control	External power supply: Input 100-240Vac 50-60Hz. Output 6Vdc 1A
B-382PH-ALC	Binocular 30° inclined	Wide Field 10X/20 mm	PLAN 4x, 10xPh, 40xPh, 100xPh (oil)	Quintuple nosepiece, reversed	Double layer mechanical sliding stage, 160x140mm, moving range 78x54mm	Coaxial coarse and fine focusing with limit stop	Phase condenser (10x/20x, 40x, 100x) with darkfield (dry) and brightfield	X-LED ³ , with Automatic Light Control	External power supply: Input 100-240Vac 50-60Hz. Output 6Vdc 1A
B-383PH	Trinocular 360°rotating 30° inclined	Wide Field 10X/20 mm	PLAN 4x, 10xPh, 40xPh, 100xPh (oil)	Quintuple nosepiece, reversed	Double layer mechanical sliding stage, 160x140mm, moving range 78x54mm	Coaxial coarse and fine focusing with limit stop	Phase condenser (10x/20x, 40x, 100x) with darkfield (dry) and brightfield	X-LED ³ , with manual brightness control	External power supply: Input 100-240Vac 50-60Hz. Output 6Vdc 1A
B-382PHi-ALC	Binocular 30° inclined	Wide Field 10X/20 mm	IOS PLAN 10xPh, 20xPh, 40xPh, 100xPh (oil)	Quintuple nosepiece, reversed	Double layer mechanical sliding stage, 216x150mm, moving range 78x54mm, Belt-drive in X direction	Coaxial coarse and fine focusing with limit stop	Phase condenser (10x/20x, 40x, 100x) with darkfield (dry) and brightfield	X-LED ³ , with Automatic Light Control	External power supply: Input 100-240Vac 50-60Hz. Output 6Vdc 1A
B-383PHi	Trinocular 360°rotating 30° inclined	Wide Field 10X/20 mm	IOS PLAN 10xPh, 20xPh, 40xPh, 100xPh (oil)	Quintuple nosepiece, reversed	Double layer mechanical sliding stage, 216x150mm, moving range 78x54mm, Belt-drive in X direction	Coaxial coarse and fine focusing with limit stop	Phase condenser (10x/20x, 40x, 100x) with darkfield (dry) and brightfield	X-LED ³ , with manual brightness control	External power supply: Input 100-240Vac 50-60Hz. Output 6Vdc 1A
B-383DK	Trinocular 360°rotating 30° inclined	Wide Field 10X/20 mm	E-PLAN 4x, 10x, 40x, Planachromatic 100x (oil, with iris diaphragm)	Quintuple nosepiece, reversed	Double layer mechanical sliding stage, 160x140mm, moving range 78x54mm	Coaxial coarse and fine focusing with limit stop	N.A.1.25 Abbe and extra N.A.1.36 darkfield type with built-in X-LED ³	X-LED ³ , with manual brightness control	External power supply: Input 100-240Vac 50-60Hz. Output 6Vdc 1A

B-380 Series - Accessories

B-380

M-160	Eyepiece WF10x/20mm.
M-161	Eyepiece EW15x/16mm.
M-162	Eyepiece WF20x/10mm.
M-163	Micrometer eyepiece WF10x/20mm.
M-005	Micrometric slide 26x76 mm, range 1 mm, div. 0,01 mm.
M-164	Objective 4x/0,10 E-PLAN.
M-165	Objective 10x/0,25 E-PLAN.
M-166	Objective 20x/0,40 E-PLAN.
M-167	Objective 40x/0,65 E-PLAN.
M-168	Objective 60x/0,80 E-PLAN.
M-169	Objective 100x/1,25 E-PLAN (Oil).
M-144	Objective 4x/0,10 IOS E-PLAN.
M-145	Objective 10x/0,25 IOS E-PLAN.
M-146	Objective 20x/0,40 IOS E-PLAN.
M-147	Objective 40x/0,65 IOS E-PLAN.
M-149	Objective 60x/0,80 IOS E-PLAN.
M-148	Objective 100x/1,25 IOS E-PLAN (Oil).
M-059	Objective with iris diaphragm for darkfield PL100x (oil).
M-170	Objective 10x/0.25 PLAN for phase contrast.
M-171	Objective 20x/0.40 PLAN for phase contrast.
M-172	Objective 40x/0.65 PLAN for phase contrast.
M-182	Objective 100x/1.25 (oil) PLAN for phase contrast.
M-183	Objective 10x/0.25 IOS PLAN for phase contrast.
M-176	Objective 20x/0.40 IOS PLAN for phase contrast.
M-177	Objective 40x/0.65 IOS PLAN for phase contrast.
M-178	Objective 100x/1.25 (oil) IOS PLAN for phase contrast.
M-179	Complete Phase Contrast Set with PLAN obj. 10x, 40x, 100x , with Darkfield position.
M-181	Complete Phase Contrast Set with IOS PLAN obj. 10x, 20x, 40x, 100x , with Darkfield position.
M-174.1	Polarizing set, filters only (for B-380 series).
M-175	Rotating table for polarizing set.
M-185	Darkfield condenser for dry objectives.
M-173	Photo adapter for APS-C and Full Frame Reflex cameras.
M-114	C-Mount adapter for 1/2" sensor.
M-116	C-Mount adapter for 2/3" sensor.
M-666.380	Heating stage, with digital temperature controller.

M-069 - Solar battery pack

Included battery: rechargeable
Lithium-Poly. Capacity: 2600 mAh.
Output voltage: 5,5Vdc.
Dimensions: 120x73x10 mm.
Autonomy: over 6 hours at medium intensity (X-LED³).
Charging modes: with solar panel (12h), with external USB power supply (not included) or from PC USB port (5h).



15104 - Lens cleaner, 50ml

It cleans glass quickly and effectively, without leaving residue or odor.
Ideal for precision lens or prism cleaning.



How to connect the cameras to our microscopes.

Please refer to the Adapter reference list on Digital section.

B-500 Series

High quality upright laboratory microscopes



B-500 Series

The B-500 microscopes have been designed for the best performance in routine laboratory use.

According to the models, two different optical systems are available (InfiniFix and IOS).

With InfiniFix optical system, the two worlds of infinity-corrected and 160 mm optical system find the way to meet each other. With this exclusive optical system all InfiniFix models use a true infinity-corrected optical path, implemented with standard 160 mm objectives. IOS simply means "Infinity Optical System". All IOS models of B-500 series are equipped with true Infinity Corrected Objectives.

B-500Bsp	Binocular microscope, Semi-plan objectives 4x, 10x, 40x, 100x, halogen illumination.
B-500Tsp	Trinocular microscope, Semi-plan objectives 4x, 10x, 40x, 100x, halogen illumination.
B-500Bpl	Binocular microscope, Plan objectives 4x, 10x, 40x, 100x, X-LED illumination.
B-500Tpl	Trinocular microscope, Plan objectives 4x, 10x, 40x, 100x, X-LED illumination.
B-500Bi	Binocular microscope, Plan IOS objectives 4x, 10x, 40x, 100x, X-LED illumination.
B-500Ti	Trinocular microscope, Plan IOS objectives 4x, 10x, 40x, 100x, X-LED illumination.
B-500ERGO	Binocular microscope, ERGO head, Plan objectives 4x, 10x, 40x, 100x, X-LED illumination.
B-500iERGO	Binocular microscope, ERGO head, IOS Plan objectives 4x, 10x, 40x, 100x, X-LED illumination.
B-500Bph	Binocular microscope, Phase contrast Plan objectives 10x, 20x, 40x, 100x, X-LED illumination.
B-500Tph	Trinocular microscope, Phase contrast Plan objectives 10x, 20x, 40x, 100x, X-LED illumination.
B-500BiPh	Binocular microscope, IOS Phase contrast Plan objectives 10x, 20x, 40x, 100x, X-LED illumination.
B-500TiPh	Trinocular microscope, IOS Phase contrast Plan objectives 10x, 20x, 40x, 100x, X-LED illumination.
B-500Ti-2	Discussion microscope, 2-head, Plan IOS objectives 4x, 10x, 40x, 100x, X-LED illumination.
B-500Ti-3	Discussion microscope, 3-head, Plan IOS objectives 4x, 10x, 40x, 100x, X-LED illumination.
B-500Ti-5	Discussion microscope, 5-head, Plan IOS objectives 4x, 10x, 40x, 100x, X-LED illumination.
B-500TDK	Trinocular microscope for immersion darkfield technique X-LED system.

Special additional versions

B-500TiFL	Trinocular EPI fluorescence microscope, HBO illumination system. (Information in FLUO SERIES)
B-500POL	Polarizing laboratory microscope, X-LED illumination. (Information in POL SERIES)
B-500POL-I	Polarizing laboratory microscope, X-LED incident & transmitted illumination. (Information in POL SERIES)
B-500MET	Upright Metallurgical Microscope, IOS MET objectives, X-LED incident & transmitted illumination. (Information in INDUSTRY SERIES)
B-500ASB	Trinocular microscope, Plan objectives 4x, 10x, 40x, 40xPh, 100x, X-LED illumination, Walton & Beckett 12,5x Eyepiece.

B-500TDK: Brief introduction to our darkfield system for blood analysis



Two great solutions together:
- our 1.36 1.25 N.A. special extra efficient darkfield condenser
- OPTIKA X-LED™ illuminator (integrated into the condenser).
RESULTS: our immersion darkfield system provides the same result achieved by 150W external illuminators in combination with traditional cardioid darkfield condenser.

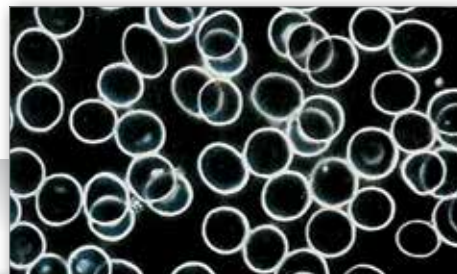

B-500 Series - Specifications

OPTIKA is proud to introduce its own revolutionary LED powered illumination system.

Developed by our R&D dept., it consists of a new combination of LED and optical technology.

A new high-efficiency single chip LED works in combination with a special optical lens, which allows to double the intensity of the light generated by the LED itself. The result is a quantity of light equivalent to the light generated by a normal 50W halogen bulb, but with a colour temperature of 6300K. It means white light instead of the yellow one produced by halogen bulbs. The electrical consumption (3.6W only) shows the high efficiency of the system: same light intensity with less than 10% of the consumption of a normal halogen bulb.

Last but not least, the lifetime of our LED: 50.000 hours, instead of 1.500 hours.



B-500Ti

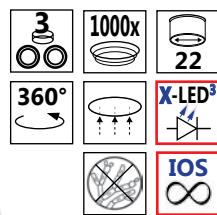

Optical system & objectives

S-Plan and Plan 160mm Finity Corrected Objectives on InfiniFix models.
Plan Infinity corrected objectives on all IOS models.

Microscope stand

The modern stand design, with accessible and ergonomic controls, complements and enhances the instrument's usability.

Head

The wide 22 mm field of view and the high-point eyepieces allow for hours of use without eye fatigue.

Illuminators

The B-500 microscopes are equipped with two kinds of illuminators (both with field diaphragm): high-efficiency dichroic 20W halogen illuminator (models with SEMI-PLAN objectives), or our special X-LED illuminator (models with PLAN objectives). Both systems permit light-intensive applications, such as phase contrast or darkfield, without the need of complex active cooling and keeping the electrical consumption at lowest levels.

Condenser

Two kinds of swing-out condensers are available (depending on the models):

- 0.10/1.20 N.A. for better performances with high magnifications;
- 0.22/0.90 N.A. for better performances with low magnifications (pathology).

Specimen stage

A generously sized double layer stage, suitable for two specimen slides, optimally completes the instrument.

175x145mm, X-Y range: 76x51mm.

Standard LED

X-LED³ illumination system

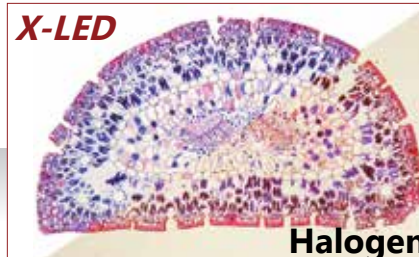

Halogen

B-500 Series - Models

Special version for asbestos analysis

Eyepieces
Walton-Beckett

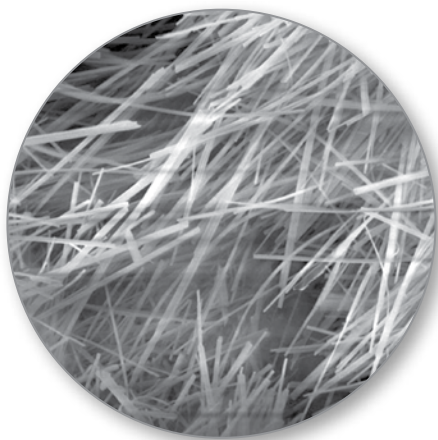
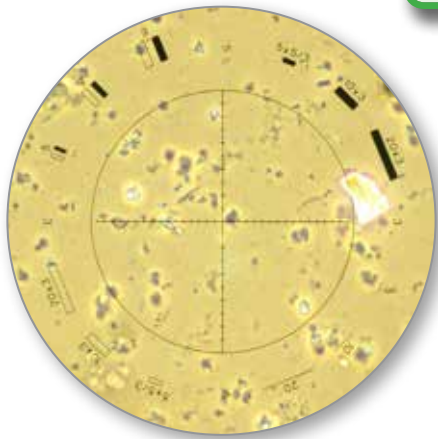

B-500ASB

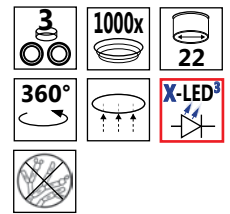

B-500 Series - Models

A complete range of instruments

B-500Tpl

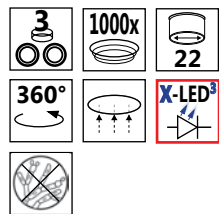

infinifix™
optical system

X-LED³

B-500iERGO

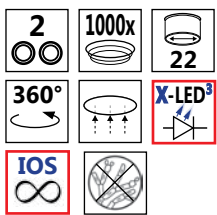

X-LED³

IOS™
objectives

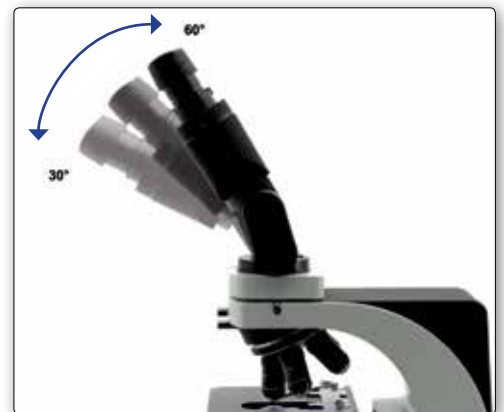

B-500 Series - Models

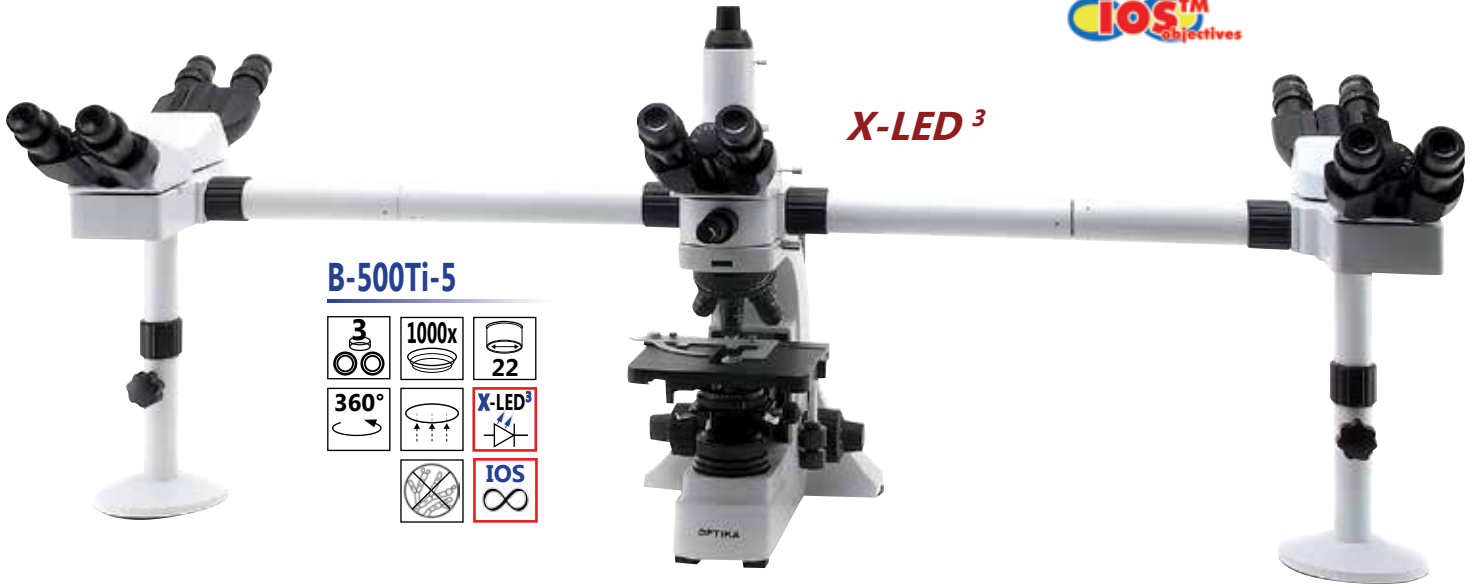

B-500Ti-5



B-500BiPh

B-500 Series - Technical specifications

Model	Optical System	Head	Eyepiece	Objectives	Nosepiece	Stage	Focusing	Condenser	Illuminator
B-500Bsp	InfiniFix	Binocular 360°rotating 30° inclined	Wide Field 10X / 22 mm	S-planachromatic 4x, 10x, 40x, 100x (oil)	Quintuple reversed	2-layer mechanical sliding stage, 175x145 mm	Coaxial coarse and fine control knobs	Swing-out 1.2 N.A., centrable	High efficiency Halogen 20W dichroic bulb
B-500Tsp	InfiniFix	Trinocular 360°rotating 30° inclined	Wide Field 10X / 22 mm	S-planachromatic 4x, 10x, 40x, 100x (oil)	Quintuple reversed	2-layer mechanical sliding stage, 175x145 mm	Coaxial coarse and fine control knobs	Swing-out 1.2 N.A., centrable	High efficiency Halogen 20W dichroic bulb
B-500Bpl	InfiniFix	Binocular 360°rotating 30° inclined	Wide Field 10X / 22 mm	Planachromatic 4x, 10x, 40x, 100x (oil)	Quintuple reversed	2-layer mechanical sliding stage, 175x145 mm	Coaxial coarse and fine control knobs	Swing-out 1.2 N.A., centrable	OPTIKA X-LED ³ illuminator
B-500Tpl	InfiniFix	Trinocular 360°rotating 30° inclined	Wide Field 10X / 22 mm	Planachromatic 4x, 10x, 40x, 100x (oil)	Quintuple reversed	2-layer mechanical sliding stage, 175x145 mm	Coaxial coarse and fine control knobs	Swing-out 1.2 N.A., centrable	OPTIKA X-LED ³ illuminator
B-500Bi	IOS	Binocular 360°rotating 30° inclined	Wide Field 10X / 22 mm	Infinity Plana- chromatic 4x, 10x, 40x, 100x (oil)	Quintuple reversed	2-layer mechanical sliding stage, 175x145 mm	Coaxial coarse and fine control knobs	Swing-out 0.90 N.A., centrable	OPTIKA X-LED ³ illuminator
B-500Ti	IOS	Trinocular 360°rotating 30° inclined	Wide Field 10X / 22 mm	Infinity Plana- chromatic 4x, 10x, 40x, 100x (oil)	Quintuple reversed	2-layer mechanical sliding stage, 175x145 mm	Coaxial coarse and fine control knobs	Swing-out 0.90 N.A., centrable	OPTIKA X-LED ³ illuminator
B-500ERGO	InfiniFix	30°-60° ergonomical bino head 360°rotating	Wide Field 10X / 22 mm	Planachromatic 4x, 10x, 40x, 100x (oil)	Quintuple reversed	2-layer mechanical sliding stage, 175x145 mm	Coaxial coarse and fine control knobs	Swing-out 1.2 N.A., centrable	OPTIKA X-LED ³ illuminator
B-500iERGO	IOS	30°-60° ergonomical bino head 360°rotating	Wide Field 10X / 22 mm	Infinity Plana- chromatic 4x, 10x, 40x, 100x (oil)	Quintuple reversed	2-layer mechanical sliding stage, 175x145 mm	Coaxial coarse and fine control knobs	Swing-out 0.90 N.A., centrable	OPTIKA X-LED ³ illuminator
B-500BPh	InfiniFix	Binocular 360°rotating 30° inclined	Wide Field 10X / 22 mm	Planachroma- tic for phase contrast 10x, 20x, 40x, 100x (oil)	Quintuple reversed	2-layer mechanical sliding stage, 175x145 mm	Coaxial coarse and fine control knobs	-PH condenser 1,25 N.A. -Brightfield swing-out 1,2 N.A. -Both with centering system.	OPTIKA X-LED ³ illuminator
B-500TPh	InfiniFix	Trinocular 360°rotating 30° inclined	Wide Field 10X / 22 mm	Planachroma- tic for phase contrast 10x, 20x, 40x, 100x (oil)	Quintuple reversed	2-layer mechanical sliding stage, 175x145 mm	Coaxial coarse and fine control knobs	-PH condenser 1,25 N.A. -Brightfield swing-out 1,2 N.A. -Both with centering system.	OPTIKA X-LED ³ illuminator
B-500BiPh	IOS	Binocular 360°rotating 30° inclined	Wide Field 10X / 22 mm	Infinity Plana- chromatic for phase contrast 10x, 20x, 40x, 100x (oil)	Quintuple reversed	2-layer mechanical sliding stage, 175x145 mm	Coaxial coarse and fine control knobs	-PH condenser 1,25 N.A. -Brightfield swing-out 0,90 N.A. -Both with centering system.	OPTIKA X-LED ³ illuminator
B-500TiPh	IOS	Trinocular 360°rotating 30° inclined	Wide Field 10X / 22 mm	Infinity Plana- chromatic for phase contrast 10x, 20x, 40x, 100x (oil)	Quintuple reversed	2-layer mechanical sliding stage, 175x145 mm	Coaxial coarse and fine control knobs	-PH condenser 1,25 N.A. -Brightfield swing-out 0,90 N.A. -Both with centering system.	OPTIKA X-LED ³ illuminator
B-500TDK	InfiniFix	Trinocular 360°rotating 30° inclined	Wide Field 10X / 22 mm	Planachromatic 4x, 10x, 40x. Special PL100x (oil, with iris diaphragm)	Quintuple reversed	2-layer mechanical sliding stage, 175x145 mm	Coaxial coarse and fine control knobs	Swing-out 1.2 N.A., centrable. Extra N.A. 1.36 darkfield type with built-in X-LED	OPTIKA X-LED ³ illuminator
B-500Ti-2	IOS	Main Head: trino 360°/30°. 1 discussion head: bino 360°/30°	Main head: WF10X/22mm Discus- sion heads: WF10x/20mm	Infinity Planachromatic 4x, 10x, 40x, 100x (oil)	Quintuple reversed	2-layer mechanical sliding stage, 175x145 mm	Coaxial coarse and fine control knobs	Swing-out 0.90 N.A., centrable	OPTIKA X-LED ³ illuminator. Discussion laser pointer under the head
B-500Ti-3	IOS	Main Head: trino 360°/30° 2 discussion heads: bino 360°/30°	Main head: WF10X/22mm Discus- sion heads: WF10x/20mm	Infinity Planachromatic 4x, 10x, 40x, 100x (oil)	Quintuple reversed	2-layer mechanical sliding stage, 175x145 mm	Coaxial coarse and fine control knobs	Swing-out 0.90 N.A., centrable	OPTIKA X-LED ³ illuminator. Discussion laser pointer under the head
B-500Ti-5	IOS	Main Head: trino 360°/30° 4 discussion heads: bino 360°/30°	Main head: WF10X/22mm Discus- sion heads: WF10x/20mm	Infinity Planachromatic 4x, 10x, 40x, 100x (oil)	Quintuple reversed	2-layer mechanical sliding stage, 175x145 mm	Coaxial coarse and fine control knobs	Swing-out 0.90 N.A., centrable	OPTIKA X-LED ³ illuminator. Discussion laser pointer under the head
B-500ASB	InfiniFix	Trinocular 360° rotating 30° inclined	1 pair: 12,5X Walton-Beckett eyepieces 1 pair: Wide- field 10x/22 mm eyepieces	Planachromatic 4x, 10x, 40x, 40xPH, 100x (oil)	Quintuple reversed	2-layer mechanical sliding stage, 175x145 mm	Coaxial coarse and fine control knobs	-PH condenser 1,25 N.A. for 40XPH -Brightfield swing-out 1,2 N.A. -Both with centering system	OPTIKA X-LED ³ illuminator.

B-500 Series - Special additional versions

B-500POL

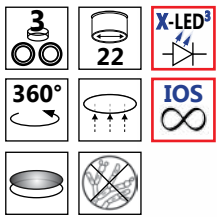

More information in
**POL SERIES
BROCHURE**



B-500POL-I

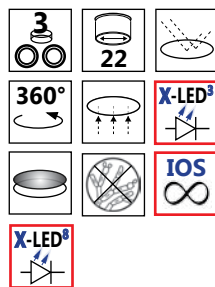

More information in
**POL SERIES
BROCHURE**



B-500 Series - Special additional versions



B-500MET

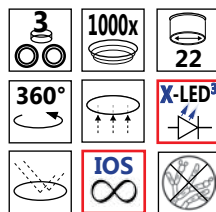

More information in
**INDUSTRY
SERIES BROCHURE**



B-500TiFL

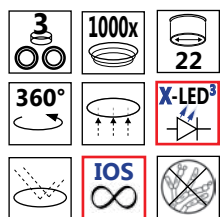

More information in
**FLUO SERIES
BROCHURE**



B-500 Series - Accessories

B-500

M-680	Ergo binocular head 30°-60°.
M-625	Eyepiece EWF10x/22mm.
M-601	Eyepiece WF15x/16mm.
M-602	Eyepiece micrometer EWF10x/22mm.
M-005	26x76 mm micrometric slide. Range 1 mm, div. 0,01 mm.
M-501	Objective 4x/0,10 S-PLAN.
M-502	Objective 10x/0,25 S-PLAN.
M-503	Objective 20x/0,40 S-PLAN.
M-504	Objective 40x/0,65 S-PLAN.
M-505	Objective 60x/0,80 S-PLAN.
M-506	Objective 100x/1,25 S-PLAN (Oil).
M-507	Objective 4x/0,10 PLAN.
M-508	Objective 10x/0,25 PLAN.
M-509	Objective 20x/0,40 PLAN.
M-510	Objective 40x/0,65 PLAN.
M-511	Objective 60x/0,85 PLAN.
M-512	Objective 100x/1,25 PLAN (Oil).
M-608	Objective 4x/0,10 PLAN IOS.
M-609	Objective 10x/0,25 PLAN IOS.
M-610	Objective 20x/0,40 PLAN IOS.
M-611	Objective 40x/0,65 PLAN IOS.
M-611.1	Objective 60x/0,80 PLAN IOS.
M-612	Objective 100x/1,25 PLAN IOS (Oil).
M-630	Objective PLAN Achromatic for phase contrast 10x/0,25.
M-631	Objective PLAN Achromatic for phase contrast 20x/0,40.
M-632	Objective PLAN Achromatic for phase contrast 40x/0,65.
M-633	Objective PLAN Achromatic for phase contrast 100x/1,25 (Oil).
M-760	Objective IOS PLAN Achromatic for phase contrast 10x/0,25.
M-761	Objective IOS PLAN Achromatic for phase contrast 20x/0,40.
M-762	Objective IOS PLAN Achromatic for phase contrast 40x/0,65.
M-763	Objective IOS PLAN Achromatic for phase contrast 100x/1,25 (Oil).
M-059	Objective 100x/1,25 (Oil) PLAN Achromatic with iris diaphragm for darkfield.
M-613	Polarising set (Polarizer and Analyzer filters).
M-614	Rotating table for polarising set.
M-618	Darkfield condenser for dry objectives.
M-616	Complete phase contrast set with plan obj. 10x, 20x, 40x, 100x.
M-617	Complete phase contrast set with plan IOS obj. 10x, 20x, 40x, 100x.
M-616.1	Single phase contrast set 40x, plan objective.
M-617.1	Single phase contrast set 40x, plan IOS objective.
M-619	Photo adapter for REFLEX camera with FULL FRAME sensor.
M-699	Universal adapter for M-114, M-116, M-173 and eyepiece cameras.

M-620	Focusable C-Mount adapter for 1/3" sensor.
M-620.1	Focusable C-Mount adapter for 1/2" sensor.
M-620.2	Focusable C-Mount adapter for 2/3" sensor.
M-515	Halogen bulb 12V/20W, with dichroic mirror.
M-034	Dust cover type 5.
M-975	Blue filter, 45 mm diameter.
M-977	Green filter, 45 mm diameter.
M-979	Yellow filter, 45 mm diameter.
M-989	Frosted glass filter, 45 mm diameter.
ST-036	Eyecup (pair).
M-173	Photo adapter for APS-C and Full Frame Reflex cameras.
M-114	C-Mount adapter for 1/2" sensor.
M-116	C-Mount adapter for 2/3" sensor.
M-113.1	Ring adapter, 30mm (for monocular and binocular microscopes).
M-778	C-mount adapter for 1/3", 1/2" and 2/3" sensor.
M-666.500	Heating stage, with digital temperature controller B-500.
M-666.500ph	Heating stage, with digital temperature controller B-500Ph.
15008	OPTIKA immersion oil 10ml.



How to connect the cameras to our microscopes.

Please refer to the Adapter reference list on Digital section.

15104 - Lens cleaner, 50ml

It cleans glass quickly and effectively, without leaving residue or odor. Ideal for precision lens or prism cleaning.



B-800 Series

Research microscopes



B-800BF Model - Brightfield version

OPTIKA Microscopes, thanks to the long experience achieved in microscopy development, has conceived the new B-800: a major leap in our technological offer. As a flagship instrument, B-800 originates, from customer most demanding feedbacks and needs. Its modularity and versatility will allow to find the perfect place in any clinical or basic research laboratory. All controls are easily accessible and comfortable also for extended periods of observation. The highest category of optical equipment among our product range guarantees a sharp and clear view in any situation, while top level mechanical design offers sturdiness and a long lifetime.

B-800 is built on IOS Infinity Corrected optical system, which gives both top-notch optical performances, and the possibility to extend your instrument with the broad range of accessories and modules. X-LED illumination is the best solution to have pure white light, very intense even at higher magnification, and optimum power efficiency given by solid state source.

If you search for our best solution to your present and future professional needs, B-800 is the answer.

B-800BF

Brightfield research microscope

B-800PH

Phase contrast research microscope

B-800BF

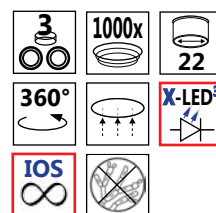

B-800BF

Type:

BRIGHTFIELD RESEARCH MICROSCOPE

Description:

Laboratory microscope for routine and research applications.

Dye-cast frame, with high stability and ergonomics, for transmitted light observation.



B-800BF Model - Configuration chart

BUILD THE MICROSCOPE THAT SUITES YOUR NEEDS BY CHOOSING AMONG THE COMPONENTS OF CONFIGURATION CHART:



B-800PH Model - Phase contrast version

B-800PH

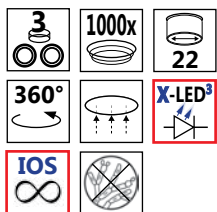

B-800PH

Type:

PHASE CONTRAST RESEARCH MICROSCOPE

Description:

Laboratory microscope for routine and research applications.

Dye-cast frame, with high stability and ergonomy, for transmitted light observation.



B-800PH Model - Configuration chart

BUILD THE MICROSCOPE THAT SUITES YOUR NEEDS BY CHOOSING AMONG THE COMPONENTS OF CONFIGURATION CHART:

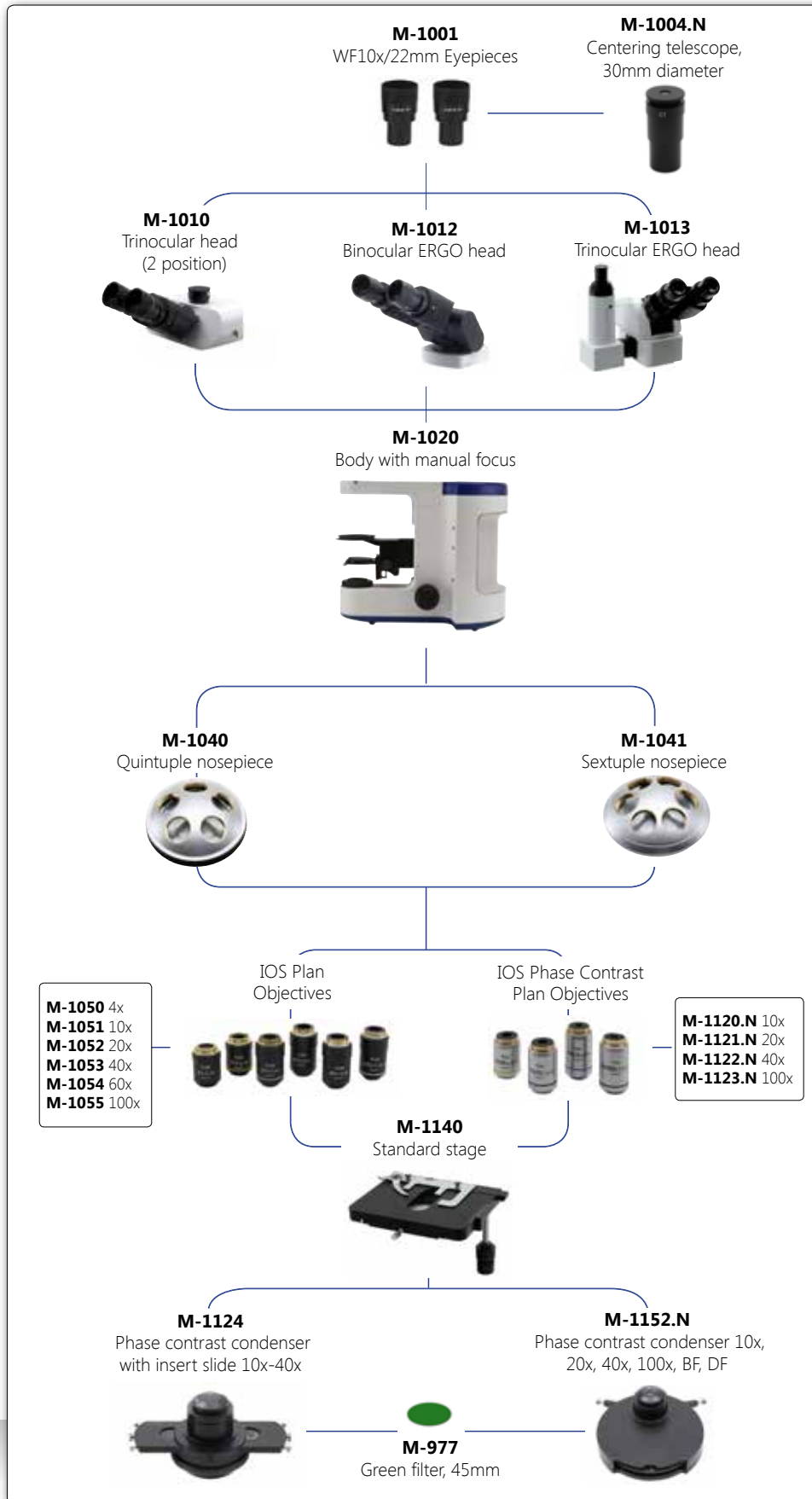

B-800 Series - Accessories

EYEPIECES

- M-1001 Eyepiece (pair) WF10x/22mm.
- M-781 Micrometer Eyepiece WF10x/22mm (10mm, 0.1mm div.).
- M-1003 Eyepiece WF15X/16mm.

HEADS

- M-1010 Trinocular Head (2 positions).
- M-1012 Binocular ERGO head.
- M-1013 Trinocular ERGO head.

NOSEPIECES

- M-1040 Quintuple nosepiece for RMS objectives.
- M-1041 Sextuple nosepiece for RMS objectives.

OBJECTIVES

- M-1050 4x IOS PLAN objective.
- M-1051 10x IOS PLAN objective.
- M-1052 20x IOS PLAN objective.
- M-1053 40x IOS PLAN objective.
- M-1054 60x IOS PLAN objective.
- M-1055 100x IOS PLAN objective.
- M-1060 4x IOS Semi-APO E-PLAN objective.
- M-1061 10x IOS Semi-APO E-PLAN objective.
- M-1062 20x IOS Semi-APO E-PLAN objective.
- M-1063 40x IOS Semi-APO E-PLAN objective.
- M-1064 100x IOS Semi-APO E-PLAN objective.
- M-1120.N 10x IOS PLAN objective, for Phase Contrast.
- M-1121.N 20x IOS PLAN objective, for Phase Contrast.
- M-1122.N 40x IOS PLAN objective, for Phase Contrast.
- M-1123.N 100x IOS PLAN objective, for Phase Contrast.

STAGES

- M-1140 Standard Mechanical Stage.
- M-1141 Belt Drive Mechanical Stage.
- M-1142 Ceramic Coated Mechanical Stage.
- M-1143 MPC (Mineral Solid Surface) Belt Drive Mechanical Stage.
- M-1144 Heating Stage.

CONDENSERS

- M-1150 0,90 N.A. Swing-Out Condenser.
- M-1151 1,25 N.A. Swing-Out Condenser.
- M-1152.N Phase contrast condenser 10x, 20x, 40x, 100x, BF, DF.
- M-618 Darkfield condenser for dry objectives (dry) spot.
- M-1124 Phase contrast condenser with insert slide 10x-40x.

ACCESSORIES

- M-1004.N Centering telescope, 30mm diameter.
- M-005 Micrometric slide, 26x76mm, range 1mm, div. 0,01mm.
- M-613 Polarizing set (Polarizer and Analyzer filters).
- M-615 Lambda filter for polarizing set.
- M-617.1N Phase contrast set with IOS PLAN objective 40x.
- M-977 Green filter, 45mm diameter.
- M-690 Eyecup (pair).
- M-619 Photo adapter for REFLEX camera with FULL FRAME sensor.
- M-173 Photo adapter for APS-C and Full Frame Reflex cameras.
- M-699 Universal adapter for M-114, M-116, M-173 and eyepiece cameras.
- M-620 Focusable C-Mount adapter for 1/3" sensor.
- M-620.1 Focusable C-Mount adapter for 1/2" sensor.
- M-620.2 Focusable C-Mount adapter for 2/3" sensor.
- M-114 C-Mount adapter for 1/2" sensor.
- M-116 C-Mount adapter for 2/3" sensor.
- M-113.1 Ring adapter, 30mm (for monocular and binocular microscopes).
- 15008 OPTIKA immersion oil, 10ml.



How to connect the cameras to our microscopes.

Please refer to the Adapter reference list on Digital section.

15104 - Lens cleaner, 50ml

It cleans glass quickly and effectively, without leaving residue or odor. Ideal for precision lens or prism cleaning.

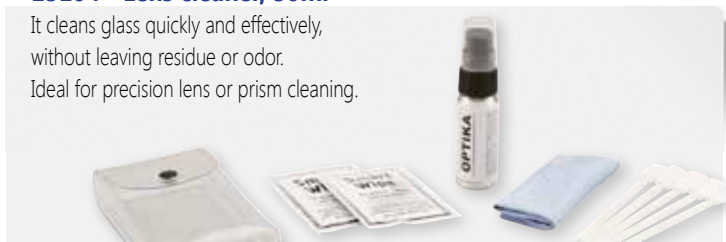

10X: M-1120.N

20X: M-1121.N



40X: M-1122.N

100X: M-1123.N

IOS (infinity corrected) Phase Contrast Plan Objectives



M-1010

Trinocular Head (2 positions)



M-1040

Quintuple revolving nosepiece, for RMS objectives



M-1124

Phase contrast condenser with insert slide 10x-40x

B-1000 Series

Modular research microscopes



B-1000 Series

OPTIKA Microscopes, thanks to the long experience achieved in microscopy development, has conceived the new B-1000: a major leap in our technological offer. As a flagship instrument, the B-1000 originates, from customer most demanding feedback and needs. Its modularity and versatility will allow to find the perfect place in any clinical or basic research laboratory. All controls are easily accessible and comfortable also for extended periods of observation. Highest category of optical equipment among our product range guarantees a sharp and clear view in any situation, while top level mechanical design offers sturdiness and long lifetime.

The B-1000 product-line is built on IOS Infinity Corrected optical system, which gives both a top-notch optical performances, and the possibility to extend your instrument with the broad range of accessories and modules. X-LED illumination is the best solution to have pure white light and very intense, even at higher magnification, and optimum power efficiency given by solid state source.

If you search for our best solution to your present and future professional needs, B-1000 is the answer.

B-1000BF	Brightfield trinocular microscope.
B-1000PH	Phase contrast trinocular microscope.
B-1000FL-LED	Trinocular microscope, LED fluorescence. (Information in FLUO SERIES)
B-1000FL-HBO	Trinocular microscope, HBO fluorescence. (Information in FLUO SERIES)
B-1000POL	Trinocular microscope, transmitted polarization. (Information in POL SERIES)
B-1000POL-I	Trinocular microscope, incident polarization. (Information in POL SERIES)
B-1000MET	Trinocular microscope, metallography. (Information in INDUSTRY SERIES)
B-1000TI-2	Trinocular discussion microscope, 2 heads.
B-1000TI-3	Trinocular discussion microscope, 3 heads.
B-1000TI-5	Trinocular discussion microscope, 5 heads.
B-1000TI-10	Trinocular discussion microscope, 10 heads.



B-1000 Series



B-1000FL-HBO



B-1000 Series - General information

Solid Stand – Extra Stability

Completely new design and a die-cast aluminium stand offer solidity and durability, even for the most demanding laboratory use.

This new microscope can seamlessly be upgraded with many attachments that extend its field of use.



B-1000FL-LED

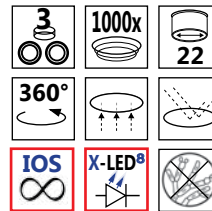

Modularity – Build your own solution

Many worlds in one instrument. Modularity allows to build the desired solution (brightfield, darkfield, phase contrast, material science, fluorescence, motorized automation and so on).

B-1000 has the flexibility to help your work the best way.



B-1000 Series - General information



X-LED White Illumination

X-LED illumination system is based on a pure white high-efficiency LED and a special optics. It guarantees constant color temperature, no heat, and an extreme electrical consumption efficiency.

The whole system is pre-aligned and boasts a lifetime of 50.000 hours.



Light under control

Intelligent control of the microscope illumination: the "AUTO-OFF" function automatically switches the light off after a user-selectable time period. "BOOST" gives an extra high level of illumination for light-demanding applications.

"AUTO" allows to store an illumination level, and to maintain it throughout the inspection.



Ergonomy

Low position focus and stage controls allow a fast and comfortable operation. Frequently used controls as light intensity adjustment and diaphragm are also placed in the lower part of the stand and enable operation without having to take the eyes off the specimen.

All optical heads are equipped with high-point eyepieces and dioptic adjustment, for the best viewing experience.



Comfortable Stage

Refined ceramic stage, with a wide working surface and a highly precise XY movement.

B-1000 Series - General information

High Quality IOS Optical System

Infinity corrected optical system, based on planachromatic, fluorite, and semi-apochromatic objectives, designed to give sharp and clear images, both for the user and the digital camera. Quintuple and sextuple nosepieces give the flexibility to build the optics set that best suits your needs.

The system is complete with wide field, high-point eyepieces, with a field number of 24mm.



Ready for Digital Imaging

Range of adapters can accommodate for C-mount digital cameras, as well as reflex cameras. Focus adjustment gives perfectly clear digital images.

Our cameras include specific software for capturing, measuring, marking and storing your pictures. Optika Vision Pro software allows to perform image acquisition, post-processing, measurements and storage of your images. User can save a preset for later work, or even create a multi-focus composition.



B-1000 Series - General information

Remote-controlled microscope

The stage can be remote-controlled through a dedicated software: X, Y, Z axes, as well as nosepiece can be moved with a single click. Communication protocol is available for interfacing with custom software, such as automated analysis or autofocus.

X-Y-Z MOTORIZED STAGE MOTORIZED NOSEPIECE

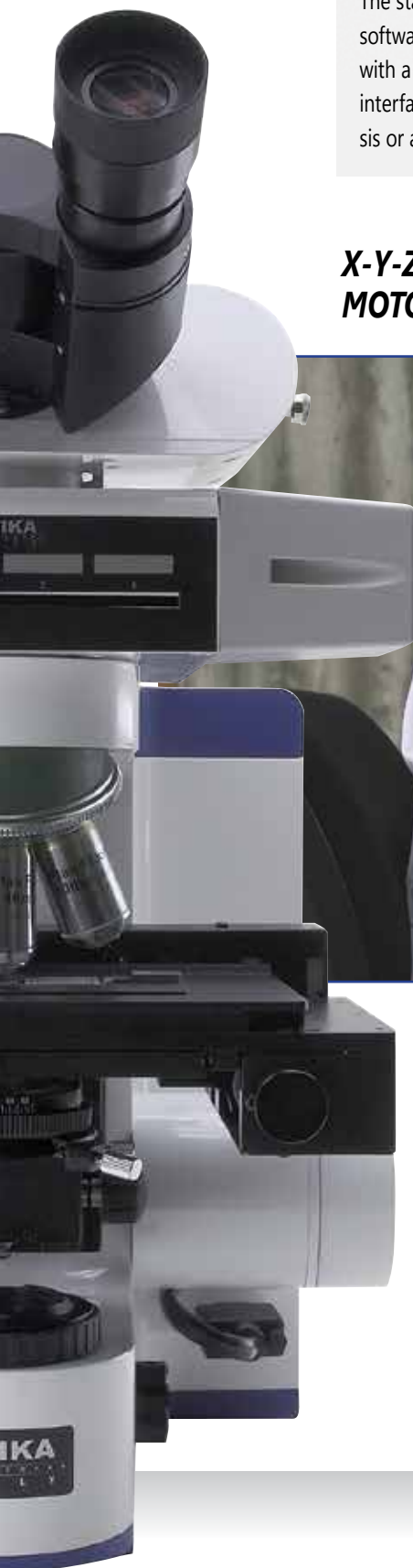

X-LED benefits

Powerful pure white LED illumination, ideal for brightfield, darkfield and phase contrast applications. Color temperature constant through all the intensity levels. No heat generation, that could damage the specimen. Factory pre-centering assures uniform illumination over the field of view, yet providing perfect Koehler alignment. Very long lifetime and high power efficiency.

B-1000 Series - Fields of application

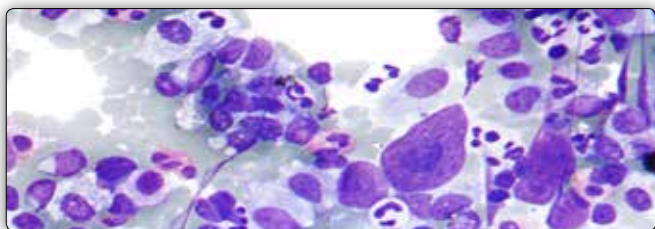

Pathology / Cytology

Since B-800 / B-1000 use white LED illumination, they can maintain the same color temperature even if the brightness is changed. "AUTO" function automatically adjusts the light intensity when the objective is changed or the aperture diaphragm is set to a different value.

These features, along with motorized stage and ergonomic controls, make your workflow easier.

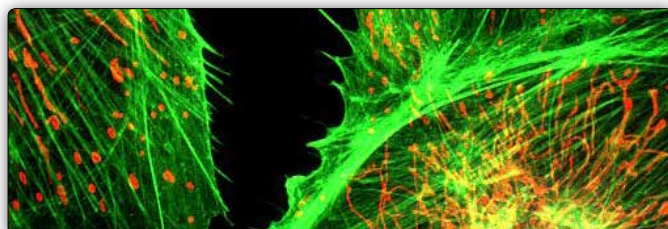

Fluorescence Microscopy

A new attachment for epi-fluorescence provides the ultimate solution in the field of fluorescence diagnostic. Vibration-free six positions filter wheel with shutter, field and aperture diaphragms, it offers all you need for a complete analysis. Custom filtersets are available and mounted on request. For application where efficiency, rapidity and ease of use are crucial, this model offers also a LED epi-fluorescence attachment, with very high power standard illuminators.

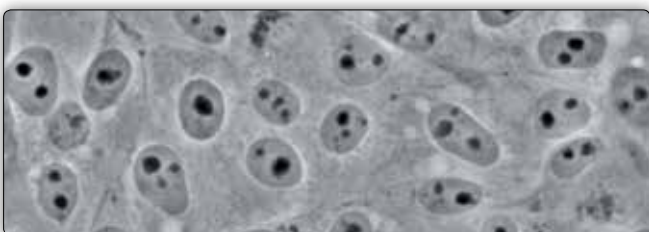

Phase Contrast Microscopy

The bright LED illuminator brings a comfortable view in phase contrast with all magnifications. Universal wheel condenser allows to quickly switch between brightfield, darkfield and phase contrast. Ideal for clinical laboratories or fibers (e.g. asbestos) analysis.

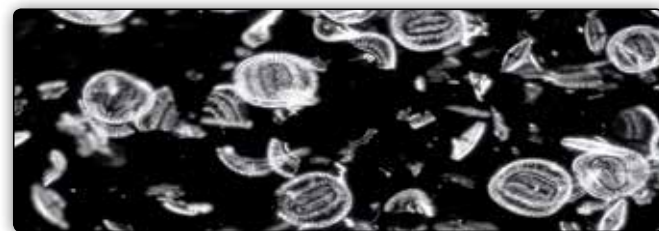

Darkfield Microscopy

Ideal for observing blood cells, diatoms, small insects, bone, fibers, unstained bacteria, yeast, protozoa, mineral and chemical crystals, colloidal particles, dust-count specimens, and thin sections of polymers and ceramics.



Material Science

A new attachment designed specifically for metallographic inspection, with dedicated objectives set, for the most complete epi-illumination analysis: brightfield, darkfield and polarizing view.

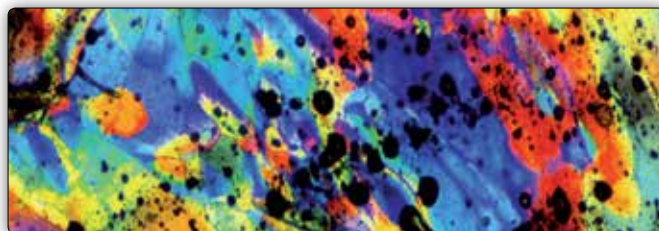

Polarizing Microscopy

Polarized light microscopy is used in geological applications or also for both natural and industrial minerals, composites such as concretes, ceramics, mineral fibers and polymers, and crystalline or biological molecules such as DNA, starch, wood and urea. Attachments for a full polarization analysis are available (both for transmitted and incident light), so it's possible to look at color fringes right away.

B-1000 Series - Dimension drawing

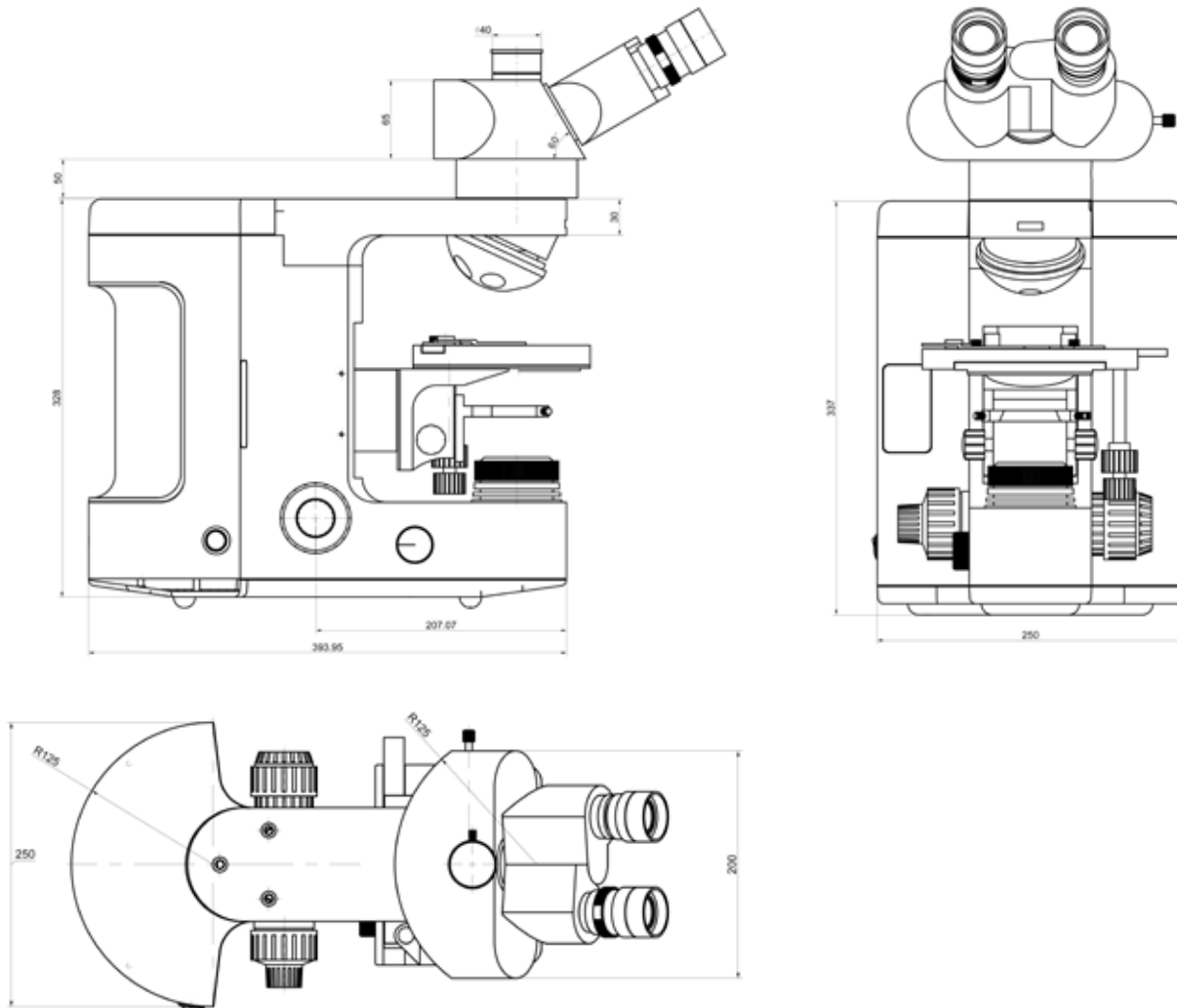

B-1000 Series - Concept art

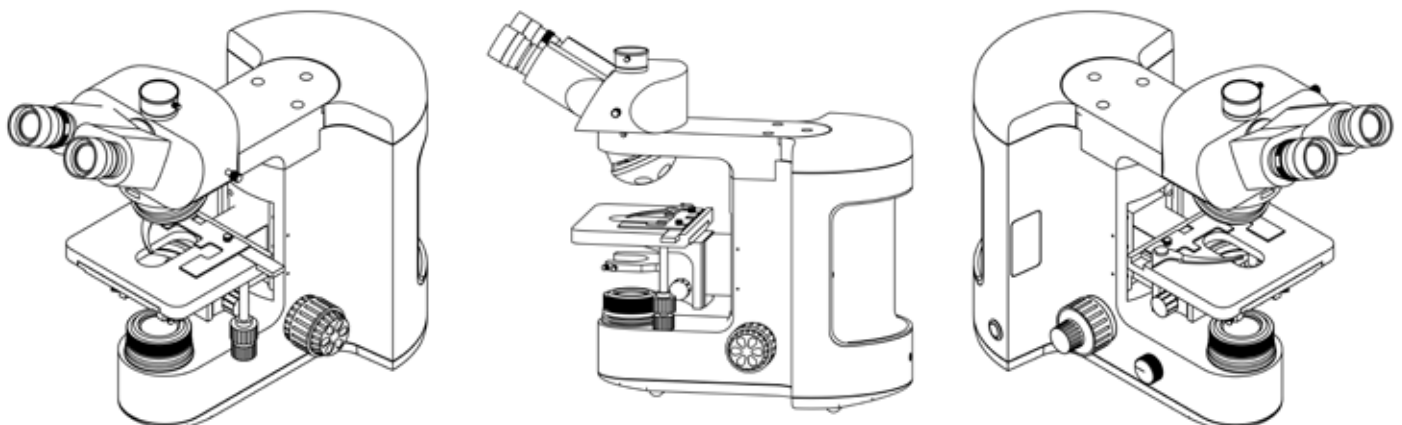

B-1000 Series - Components

Eyepieces



WF10x/22mm Eyepieces, high-point type



WF10x/24mm Eyepieces, high-point type

Heads



Trinocular Head 100/0 - 50/50 - 0/100 type



Binocular Ergonomic Head



Binocular Ergonomic Head with side Video/Photo Tube

Nosepieces



Sextuple revolving Nosepiece, for RMS objectives; with DIC slot



Sextuple motorized revolving Nosepiece, for RMS objectives; with DIC slot



Quintuple revolving Nosepiece, with centrable positions for polarizing objectives



Quintuple revolving Nosepiece for darkfield metallurgical objectives; with 3 ring adapters for brightfield objectives



Quintuple motorized revolving Nosepiece for darkfield metallurgical objectives; with 3 ring adapters for brightfield objectives motorized

B-1000 Series - Components

Objectives

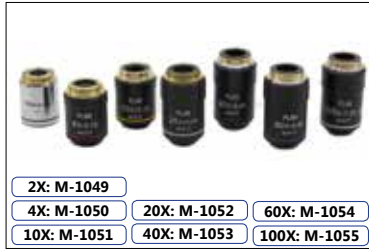

IOS (infinity corrected) Plan Objectives



IOS (infinity corrected) Semi-APO FLUO E-Plan objectives



IOS (infinity corrected) Semi-APO FLUO High-Grade Plan objectives



IOS (infinity corrected) POL Plan objectives, for transmitted polarized light



IOS (infinity corrected) LWD POL Plan objectives, for transmitted and incident polarized light



IOS LWD (infinity corrected) MET Plan objectives, for brightfield

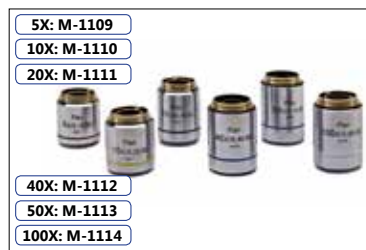

IOS LWD (infinity corrected) MET Plan objectives, for darkfield



IOS (infinity corrected) Phase Contrast Plan Objectives

Stages



Standard Mechanical Stage



Belt drive Mechanical Stage; movement knobs with friction adjustment control



MPC (mineral solid surface) Belt drive Mechanical Stage; movement knobs with friction adjustment control



Motorized stage



Metallographic stage for B-1000 MET



Heating Stage

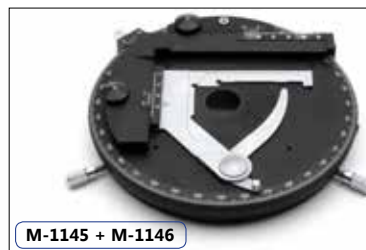

Rotating Stage + attachable XY stage

B-1000 Series - Components

Condensers



M-1150
0.90 N.A. swing-out Condenser



M-1151
1.20 N.A. swing-out Condenser



M-1153
0.90 N.A. swing-out Polarizing Condenser



M-1154
0.70 N.A. swing-out Condenser



M-1155
0.90/0.25 N.A. Swing-Out Condenser



M-618
Darkfield Condenser (dry)



M-1152.N
Phase contrast condenser 10x, 20x, 40x, 100x, BF, DF



M-1124
Phase contrast condenser with insert slide 10x-40x

Fluorescence attachments



M-1031
4-position LED Fluorescence Attachment



M-1032
6-position HBO Fluorescence attachment

Polarizing attachments



M-1033
Bertrand Lens with analyzer and Lambda slides slot



M-1034
Incident Polarizing Light attachment, with field and aperture diaphragms

Discussion heads



M-1160 - 2-Head attachment
M-1161 - 3-Head Attachment

M-1162 - 5-Head Attachment
M-1163 - 10-Head attachment

Metallurgical attachment



M-1035

Metallurgical Brightfield/Darkfield attachment, with field and aperture diaphragms, neutral density filter, and polarizer/analyzer filters.

B-1000 Series - Discussion microscope

Share your view with up to 10 persons. With built-in movable pointer, it helps any teaching or discussion experience.

- B-1000Ti-2**
- B-1000Ti-3**
- B-1000Ti-5**
- B-1000Ti-10**

B-1000Ti-5



B-1000Ti-10

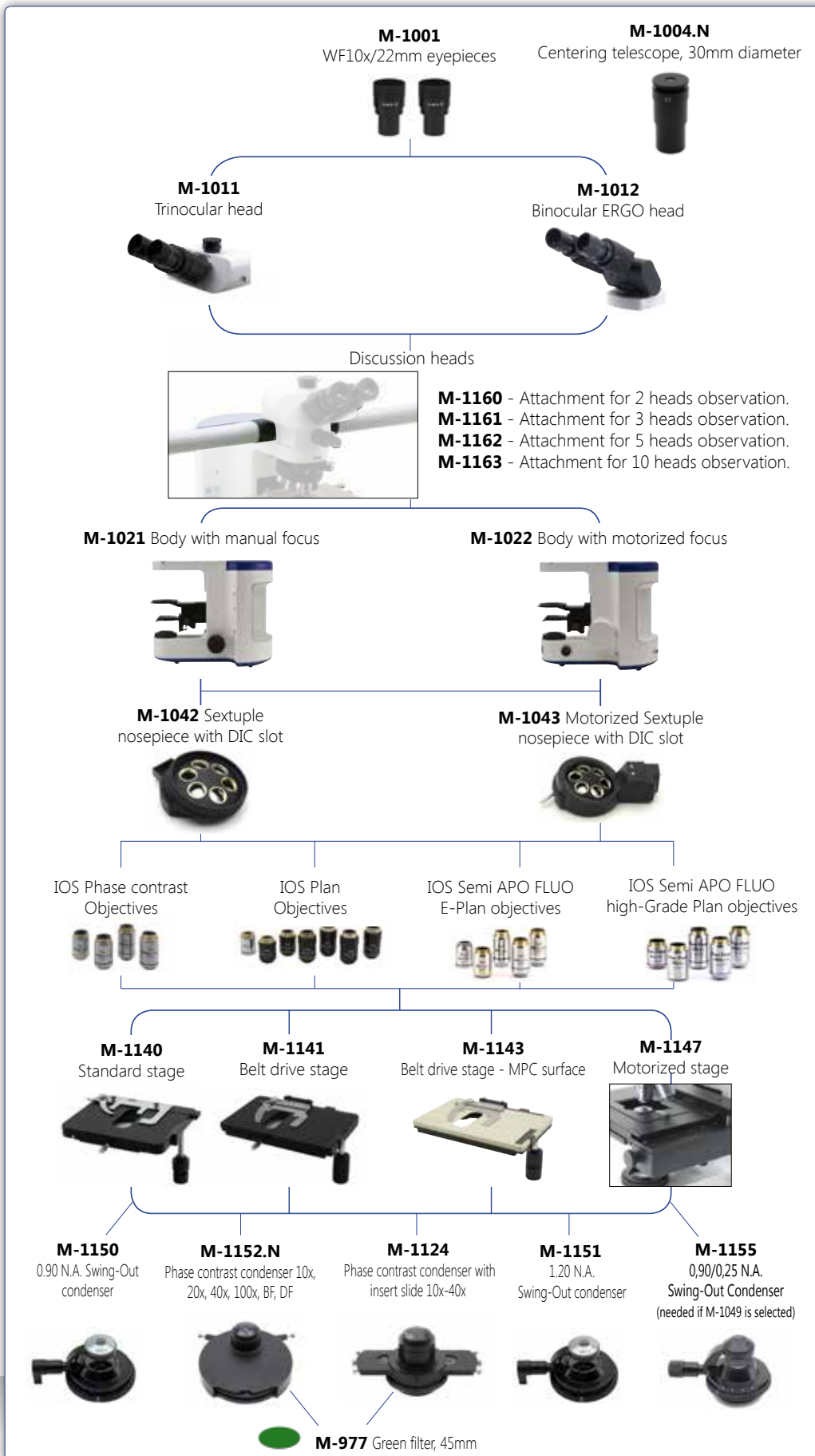

B-1000BF Model - Brightfield version



B-1000BF

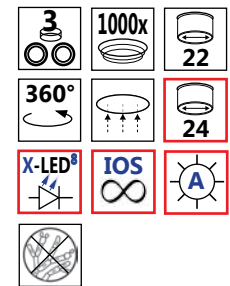

B-1000BF

Type:

BRIGHTFIELD RESEARCH MICROSCOPE

Description:

Laboratory microscope for routine and research applications.

Dye-cast frame, with high stability and ergonomomy, for transmitted light observation.



Version for standard brightfield view.
Illumination: X-LED⁸ (8W power)

B-1000BF Model - Configuration chart

BUILD THE MICROSCOPE THAT SUITES YOUR NEEDS BY CHOOSING AMONG THE COMPONENTS OF CONFIGURATION CHART:

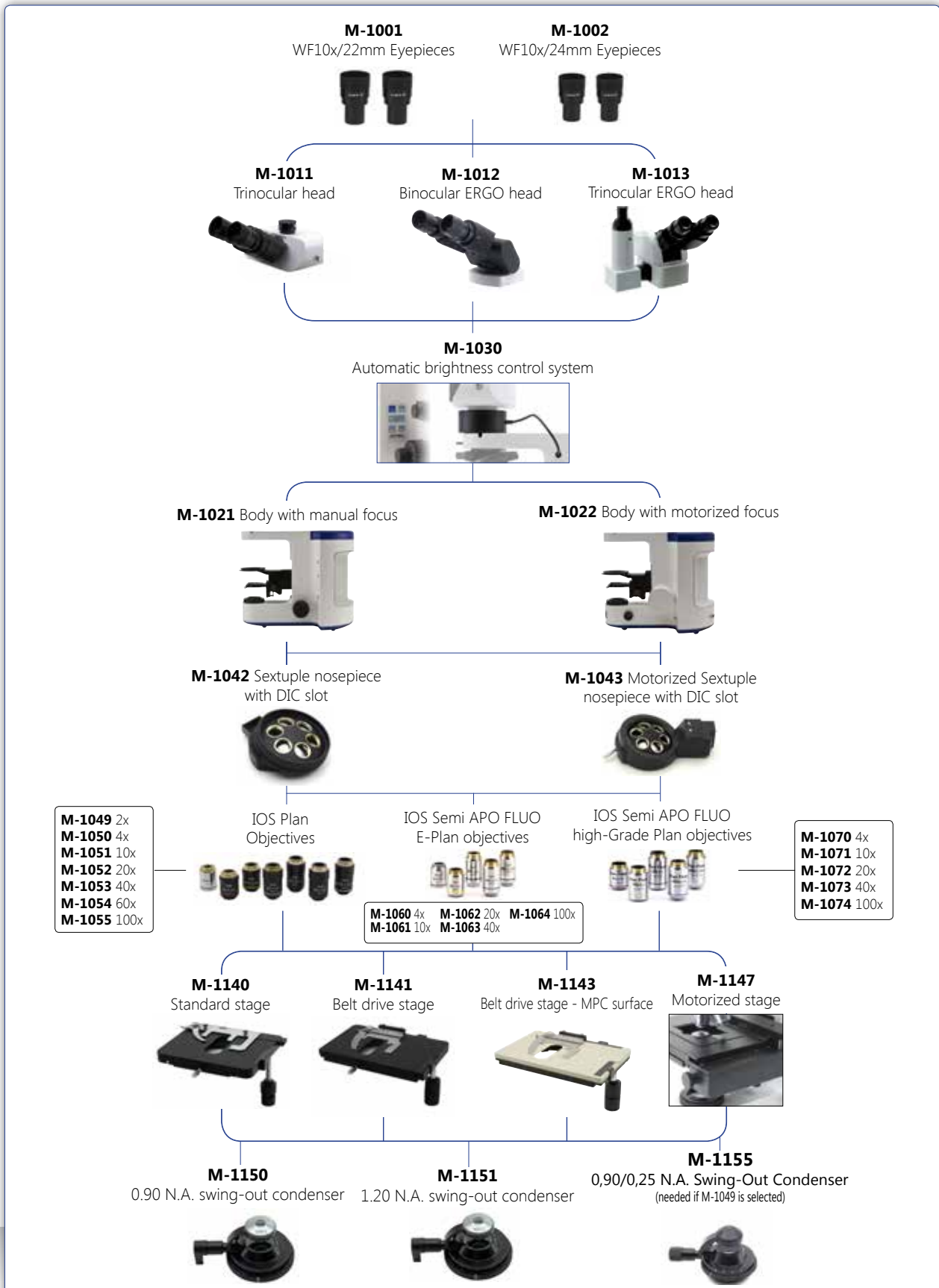

B-1000PH Model - Phase contrast version



B-1000PH

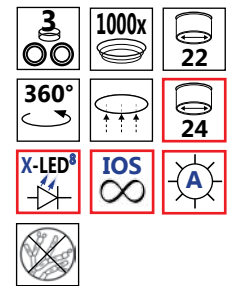

B-1000PH

Type:

PHASE CONTRAST RESEARCH MICROSCOPE

Description:

Laboratory microscope for routine and research applications.

Dye-cast frame, with high stability and ergonomy, for transmitted light observation.



Version for phase contrast analysis.
Illumination: X-LED⁸ (8W power).

B-1000PH Model - Configuration chart

BUILD THE MICROSCOPE THAT SUITES YOUR NEEDS BY CHOOSING AMONG THE COMPONENTS OF CONFIGURATION CHART:



B-1000 Series -Additional models

B-1000FL-LED

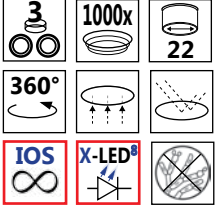

More information in
FLUO SERIES



B-1000FL-HBO

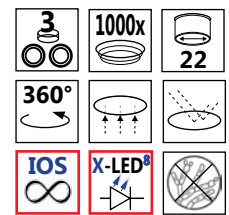

More information in
FLUO SERIES



B-1000 Series - Additional models



B-1000MET

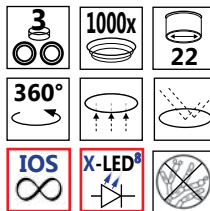

More information in
INDUSTRY SERIES

B-1000POL

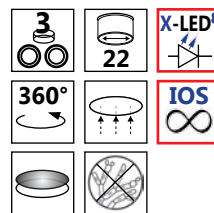

More information in
POL SERIES



B-1000POL-I

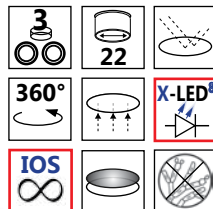

More information in
POL SERIES



B-1000 Series - Accessories

EYEPIECES

M-1001	Eyepiece (pair) WF10x/22mm.
M-781	Micrometer Eyepiece WF10x/22mm (10mm, 0.1mm div.).
M-1002	Eyepiece (pair) WF10x/24mm.
M-1003	Eyepiece WF15X/16mm.

HEADS

M-1011	Trinocular Head (3 positions).
M-1012	Binocular ERGO head.
M-1013	Trinocular ERGO head.

ATTACHMENTS

M-1030	Automatic Brightness Control System.
M-1031	4-Position LED Fluorescence attachment, with standard Blue and Green filtersets (FITC & TRITC).
M-1032	6-Position HBO Fluorescence attachment, with standard Blue and Green filtersets (FITC & TRITC).
M-1033	Bertrand Lens with Analyzer and slot for slides (with Lambda, 1/4 Lambda and Quartz Edge).
M-1034	Incident Polarizing Attachment.
M-1035	Metallurgical Attachment.

NOSEPIECES

M-1042	Sextuple nosepiece for RMS objectives with DIC slot.
M-1043	Sextuple motorized nosepiece for RMS objectives with DIC slot.
M-1044	Quintuple nosepiece with centrable positions for POL objectives.
M-1045	Quintuple nosepiece for Darkfield MET objectives, with 3 adater rings for RMS objectives
M-1046	Quintuple motorized nosepiece for Darkfield MET objectives, with 3 adater rings for RMS objectives

OBJECTIVES

M-1049	Objective 2x IOS PLAN.
M-1050	Objective 4x IOS PLAN.
M-1051	Objective 10x IOS PLAN.
M-1052	Objective 20x IOS PLAN.
M-1053	Objective 40x IOS PLAN.
M-1054	Objective 60x IOS PLAN.
M-1055	Objective 100x IOS PLAN.
M-1060	Objective 4x IOS Semi-APO E-PLAN.
M-1061	Objective 10x IOS Semi-APO E-PLAN.
M-1062	Objective 20x IOS Semi-APO E-PLAN.
M-1063	Objective 40x IOS Semi-APO E-PLAN.
M-1064	Objective 100x IOS Semi-APO E-PLAN.
M-1070	Objective 4x IOS Semi-APO High-Grade PLAN.
M-1071	Objective 10x IOS Semi-APO High-Grade PLAN.
M-1072	Objective 20x IOS Semi-APO High-Grade PLAN.
M-1073	Objective 40x IOS Semi-APO High-Grade PLAN.
M-1074	Objective 100x IOS Semi-APO High-Grade PLAN.
M-1080	Objective 4x IOS POL PLAN.
M-1081	Objective 10x IOS POL PLAN.
M-1082	Objective 40x IOS POL PLAN.
M-1083	Objective 60x IOS POL PLAN.
M-1090	Objective 5x IOS LWD POL PLAN.
M-1091	Objective 10x IOS LWD POL PLAN.
M-1092	Objective 20x IOS LWD POL PLAN.
M-1093	Objective 50x IOS LWD POL PLAN.
M-1099	Objective 2,5x IOS MET PLAN, for brightfield (with depolarizer).
M-1100	Objective 5x IOS MET PLAN, for brightfield.
M-1101	Objective 10x IOS MET PLAN, for brightfield.

M-1102	Objective 20x IOS MET PLAN, for brightfield.
M-1103	Objective 50x IOS MET PLAN, for brightfield.
M-1104	Objective 100x IOS MET PLAN, for brightfield.

M-1109	Objective 5x IOS MET PLAN, for darkfield.
M-1110	Objective 10x IOS MET PLAN, for darkfield.
M-1111	Objective 20x IOS MET PLAN, for darkfield.
M-1112	Objective 40x IOS MET PLAN, for darkfield.
M-1113	Objective 50x IOS MET PLAN, for darkfield.
M-1114	Objective 100x IOS MET PLAN, for darkfield.

M-1120.N	Objective 10x IOS PLAN, for Phase Contrast.
M-1121.N	Objective 20x IOS PLAN, for Phase Contrast.
M-1122.N	Objective 40x IOS PLAN, for Phase Contrast.
M-1123.N	Objective 100x IOS PLAN, for Phase Contrast.

STAGES

M-1140	Standard Mechanical Stage.
M-1141	Belt Drive Mechanical Stage.
M-1143	MPC (Mineral Solid Surface) Belt Drive Mechanical Stage.
M-1144	Heating Stage.
M-1145	Rotating Stage, centrable.
M-1146	Attachable mechanical stage for rotating Stage.
M-1147	Motorized mechanical Stage.
M-1148	Metallurgical Stage, with glass.

CONDENSERS

M-1150	0,90 N.A. Swing-Out Condenser.
M-1151	1,25 N.A. Swing-Out Condenser.
M-1152.N	Phase contrast condenser 10x, 20x, 40x, 100x, BF, DF.
M-1153	0,90 N.A. Swing-Out POL Condenser.
M-1154	0,70 N.A. Swing-Out MET Condenser.
M-1155	0.9/0.25 NA Swing-Out Condenser (to be used with objective M-1049).
M-618	Darkfield condenser for dry objectives.
M-1124	Phase contrast condenser with insert slide 10x-40x.

ACCESSORIES

M-1004.N	Centering telescope, 30mm diameter.
M-005	Micrometric slide, 26x76mm, range 1mm, div. 0,01mm.
M-613	Polarizing set (Polarizer and Analyzer filters)
M-615	Lambda filter for polarizing set.
M-617.1N	Phase contrast set with IOS PLAN objective 40x.
M-977	Green filter, 45mm diameter.
M-690	Eyecup (pair).
M-619	Photo adapter for REFLEX camera with FULL FRAME sensor.
M-173	Photo adapter for APS-C and Full Frame Reflex cameras.
M-699	Universal adapter for M-114, M-116, M-173 and eyepiece cameras.
M-620	Focusable C-Mount adapter for 1/3" sensor.
M-620.1	Focusable C-Mount adapter for 1/2" sensor.
M-620.2	Focusable C-Mount adapter for 2/3" sensor.
M-151	HBO 100W high-pressure mercurybulb for fluorescence.
M-1164	Empty fluorescence filterblock for B-1000 FL HBO.
M-1165	Fluorescence filterset V (filterblock included) for B-1000 FL HBO.
M-1166	Fluorescence filterset UV-DAPI (filterblock included) for B-1000 FL HBO.
M-114	C-Mount adapter for 1/2" sensor.
M-116	C-Mount adapter for 2/3" sensor.
M-113.1	Ring adapter, 30mm (for monocular and binocular microscopes).
15008	OPTIKA immersion oil, 10ml.
15104	Lens cleaner, 50ml.



How to connect the cameras to our microscopes.

Please refer to the Adapter reference list on Digital section.

POL Series

Laboratory & research polarizing microscopes



POL Series

Polarized light microscopy provides all the benefits of brightfield microscopy and offers a wealth of information, which is simply not available with any other optical microscopy technique, such as refractive indices, birefringence, retardation, extinction angle, pleochroism. Polarized light microscopy is best known for its geological applications – primarily for the study of minerals in rock thin sections, but it can also be used to study many other materials.

OPTIKA polarizing microscopes offer a complete system for your laboratory analysis, including polarizer and analyzer filters, Bertrand lens for conoscopic observation, compensator plates, and high-precision rotatable stages. Also available the X-LED illumination system, an high-intensity light source which delivers bright and clear images.

The extraordinary characteristics of this series are now accessible to all laboratories, meeting the needs of those who are looking for a prime quality instrument.

B-383POL

Trinocular polarizing microscope, E-PLAN IOS objectives.

B-500POL

Polarizing laboratory microscope, X-LED illumination.

B-500POL-I

Polarizing laboratory microscope, X-Led incident & transmitted illumination.

B-1000POL

Trinocular microscope, advanced transmitted polarization.

B-1000POL-I

Trinocular microscope, advanced transmitted and incident polarization.

B-1000POL

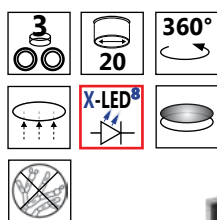

B-383POL Series - Technical specifications

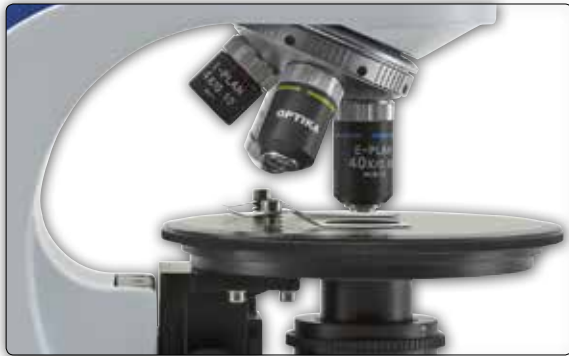

B-383POL

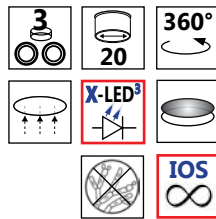

Technical specifications

Part	Description
Head	Trinocular, 30° inclined, 360° rotating.
Eyepieces	WF10X/20mm, one eyepiece with cross hair.
Bertrand lens	Swing-out type; centrable.
Polarizing attachment	0°-90° rotating analyzer filter. Tint plates included: 1° order red (λ), $\lambda/4$, quartz wedge.
Nosepiece	4-positions with centering mechanism for all objectives.
Objectives	E-PLAN IOS POL (Strain-free) 4x/0.10, 10x/0.25, 40x/0.65, 60x/0.80.
Focusing system	Coaxial coarse and fine.
Stage	160mm dia.; 360° rotating with stop knob and 0.1° Vernier.
Condenser	N.A. 1.25, with iris diaphragm, focusable and centrable. With rotating polarizer filter.
Illumination	X-LED ³ , with manual brightness control.
Power supply	External power supply: Input 100-240Vac 50-60Hz / Output 6Vdc 1A

B-500POL Model



B-500POL

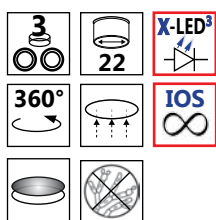

Technical specifications

Part	Description
Head	Trinocular, 30° inclined, 360° rotating.
Eyepieces	WF10X/22mm, one eyepiece with cross hair.
Bertrand lens	Swing-out type; centrable (for Conoscopy/Orthoscopy)
Polarizing attachment	0°-90° rotating analyzer filter. Tint plates included: 1° order red (λ), $\lambda/4$, quartz wedge.
Nosepiece	4-positions with centering mechanism for all objectives
Objectives	PLAN IOS POL (strain-free) 4x/0.10, 10x/0.25, 40x/0.65, 60x/0.85
Focusing system	Coaxial coarse and fine
Stage	160mm diameter; 360° rotating with stop knob and 0.1° Vernier
Condenser	0,9 N.A., with iris diaphragm, focusable and centrable. With rotating polarizing filter (swing-out type)
Illumination	X-LED ³ illumination system with brightness control

B-500POL-I Model

B-500POL-I

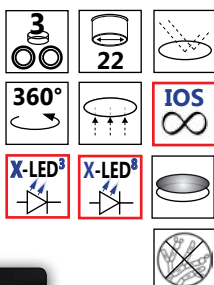

Technical specifications

Part	Description
Head	Trinocular, 30° inclined, 360° rotating
Eyepieces	WF10X/22mm, one eyepiece with cross hair.
Bertrand lens	Swing-out type; centrable (for Conoscopy/Orthoscopy)
Polarizing attachment	0°-90° rotating analyzer filter. Tint plates included: 1° order red (λ), $\lambda/4$, quartz wedge.
Nosepiece	4-positions with centering mechanism for all objectives
Objectives	LWD PLAN IOS POL (strain-free) for transmitted and incident polarized light 5x/0.15, 10x/0.3, 20x/0.45, 50x/0.55
Focusing system	Coaxial coarse and fine
Stage	160mm diameter; 360° rotating with stop knob and 0.1° Vernier
Condenser	0,9 N.A., with iris diaphragm, focusable and centrable. With rotating polarizing filter (swing-out type)
Illumination	Transmitted light: X-LED ³ system. Incident light: X-LED ⁸ system polarizing attachment with built-in polarizer filter, aperture diaphragm and field diaphragm.

B-1000POL Model - Transmitted polarization

B-1000POL

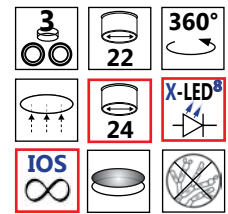

B-1000POL

Type:

TRANSMITTED POLARIZING RESEARCH MICROSCOPE

Description:

Laboratory microscope for routine and research applications.

Dye-cast frame, with high stability and ergonomy, for transmitted light observation.



Version for transmitted polarization analysis.
Illumination: X-LED⁸ (8W power).

B-1000POL Model - Configuration chart

BUILD THE MICROSCOPE THAT SUITES YOUR NEEDS BY CHOOSING AMONG THE COMPONENTS OF CONFIGURATION CHART:

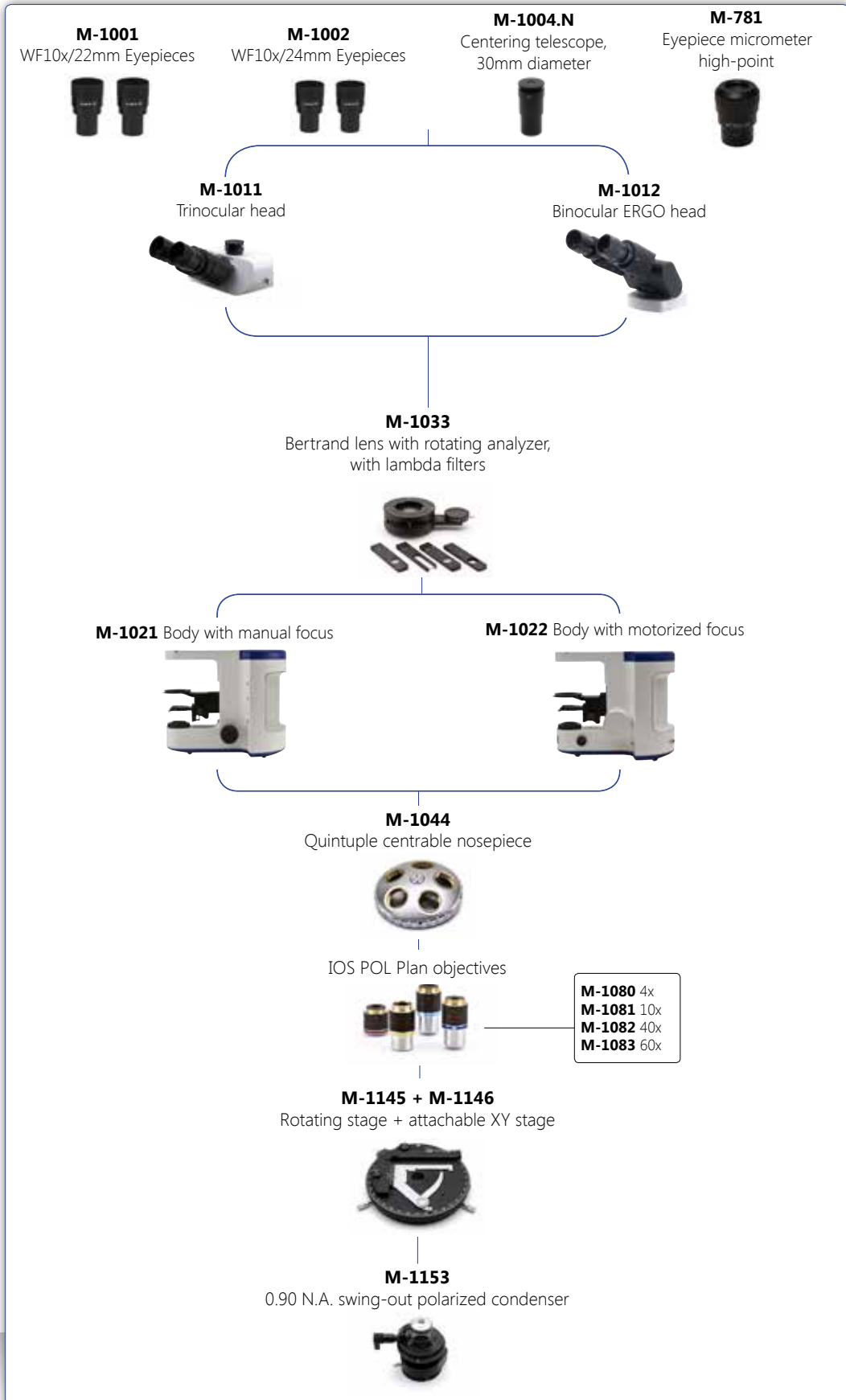

B-1000POL-I Model - Transmitted and incident polarization



B-1000POL-I

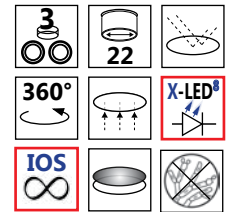

B-1000POL-I

Type:

TRANSMITTED AND INCIDENT POLARIZING RESEARCH MICROSCOPE

Description:

Laboratory microscope for routine and research applications.

Dye-cast frame, with high stability and ergonomomy, for transmitted and incident light observation.



Version for transmitted and incident polarization analysis.

Transmitted illumination: X-LED[®] (8W power).

Epi-illumination: special attachment with built-in high-power white LED.

B-1000POL-I Model - Configuration chart

BUILD THE MICROSCOPE THAT SUITES YOUR NEEDS BY CHOOSING AMONG THE COMPONENTS OF CONFIGURATION CHART:

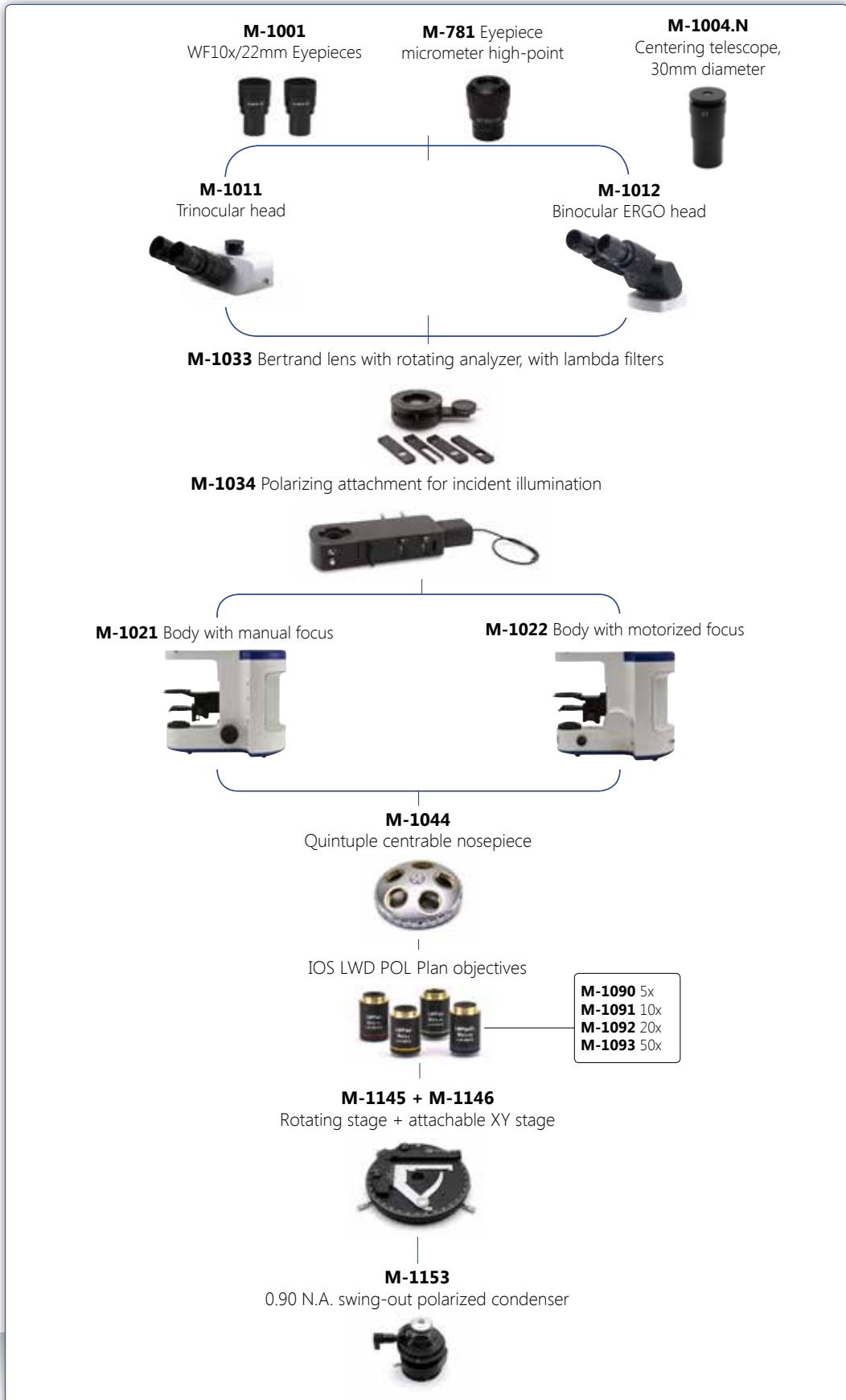

POL Series - Accessories

Accessories for B-383POL

M-160	Eyepiece WF10x/20mm.
M-161	Eyepiece EW15x/16mm.
M-162	Eyepiece WF20x/10mm.
M-163	Eyepiece micrometer WF10x/20mm.
M-005	Micrometric slide 26x76 mm, range 1 mm, div. 0,01 mm.
M-144P	Objective E-PLAN IOS POL 4x/0,10.
M-145P	Objective E-PLAN IOS POL 10x/0,25.
M-146P	Objective E-PLAN IOS POL 20x/0,40.
M-147P	Objective E-PLAN IOS POL 40x/0,65.
M-149P	Objective E-PLAN IOS POL 60x/0,80.
M-148P	Objective E-PLAN IOS POL 100x/1,25 (Oil).
M-185	Darkfield condenser for dry objectives.
M-173	Photo adapter for APS-C and Full Frame Reflex cameras.
M-114	C-Mount adapter for 1/2" sensor.
M-116	C-Mount adapter for 2/3" sensor.
M-069	Solar battery pack.

Accessories for B-1000POL / B-1000POL-I

M-1004.N	Centering telescope, 30mm diameter.
M-781	WF10x/22mm micrometer eyepiece (10mm, 0.1mm div.).
M-005	Micrometric slide, 26x76mm, range 1mm, div. 0,01mm.
ST-036	Eyecup (pair).
M-619	Photo adapter for REFLEX camera with FULL FRAME sensor.
M-173	Photo adapter for APS-C and Full Frame Reflex cameras.
M-699	Universal adapter for M-114, M-116, M-173 and eyepiece cameras.
M-620	Focusable C-Mount adapter for 1/3" sensor.
M-620.1	Focusable C-Mount adapter for 1/2" sensor.
M-620.2	Focusable C-Mount adapter for 2/3" sensor.
M-114	C-Mount adapter for 1/2" sensor.
M-116	C-Mount adapter for 2/3" sensor.
M-113.1	Ring adapter, 30mm (for monocular and binocular microscopes).
M-617.1N	Phase contrast set with IOS PLAN objective 40x.

15104 - Lens cleaner, 50ml

It cleans glass quickly and effectively, without leaving residue or odor.
Ideal for precision lens or prism cleaning.



M-069 - Solar battery pack

Included battery: rechargeable – Lithium-Poly. Capacity: 2600 mAh.
Output voltage: 5,5Vdc.
Dimensions: 120x73x10 mm.
Autonomy: over 6 hours at medium intensity (X-LED³).
Charging modes: with solar panel (12h),
with external USB power supply (not included)
or from PC USB port (5h).



Accessories for B-500POL

M-680	Ergo binocular head 30°-60°.
M-780	Eyepiece EWF10x/22mm.
M-601	Eyepiece WF15x/16mm.
M-781	Eyepiece micrometer EWF10x/22mm.
M-005	26x76 mm micrometric slide. Range 1 mm, div. 0,01 mm.
M-691	Objective IOS POL PLAN Achromatic 4x/0,10.
M-692	Objective IOS POL PLAN Achromatic 10x/0,25.
M-692.5	Objective IOS POL PLAN Achromatic 20x/0,45.
M-693	Objective IOS POL PLAN Achromatic 40x/0,65.
M-694	Objective IOS POL PLAN Achromatic 60x/0,85.
M-619	Photo adapter for REFLEX camera with FULL FRAME sensor.
M-699	Universal adapter for M-114, M-116, M-173 and eyepiece cameras
M-620	Focusable C-Mount adapter for 1/3" sensor.
M-620.1	Focusable C-Mount adapter for 1/2" sensor.
M-620.2	Focusable C-Mount adapter for 2/3" sensor.
M-034	Dust cover type 5.
M-975	Blue filter, 45 mm diameter.
M-977	Green filter, 45 mm diameter.
M-979	Yellow filter, 45 mm diameter.
M-989	Frosted glass filter, 45 mm diameter.
ST-036	Eyecup (pair).
M-173	Photo adapter for APS-C and Full Frame Reflex cameras
M-114	C-Mount adapter for 1/2" sensor.
M-116	C-Mount adapter for 2/3" sensor.

Accessories for B-500POL-I

M-680	Ergo binocular head 30°-60°.
M-780	Eyepiece EWF10x/22mm.
M-601	Eyepiece WF15x/16mm.
M-781	Eyepiece micrometer EWF10x/22mm.
M-005	26x76 mm micrometric slide. Range 1 mm, div. 0,01 mm.
M-695	Objective IOS POL LWD PLAN Achromatic 5x.
M-696	Objective IOS POL LWD PLAN Achromatic 10x.
M-697	Objective IOS POL LWD PLAN Achromatic 20x.
M-688	Objective IOS POL LWD PLAN Achromatic 50x.
M-619	Photo adapter for REFLEX camera with FULL FRAME sensor.
M-699	Universal adapter for M-114, M-116, M-173 and eyepiece cameras
M-620	Focusable C-Mount adapter for 1/3" sensor.
M-620.1	Focusable C-Mount adapter for 1/2" sensor.
M-620.2	Focusable C-Mount adapter for 2/3" sensor.
M-034	Dust cover type 5.
M-975	Blue filter, 45 mm diameter.
M-977	Green filter, 45 mm diameter.
M-979	Yellow filter, 45 mm diameter.
M-989	Frosted glass filter, 45 mm diameter.
ST-036	Eyecup (pair).
M-173	Photo adapter for APS-C and Full Frame Reflex cameras.
M-114	C-Mount adapter for 1/2" sensor.
M-116	C-Mount adapter for 2/3" sensor.



How to connect the cameras to our microscopes.

Please refer to the Adapter reference list on Digital section.

FLUO Series

Upright and inverted epi-fluorescence microscopes



FLUO Series

A complete range of microscopes, designed to meet your needs in fluorescence microscopy. Quality, innovative technology, power, safety and simplicity of use are the common characteristics of these instruments.

B-383LD1	Trinocular LED fluorescence microscope, E-PLAN IOS objectives, B filterset.
B-383LD2	Trinocular LED fluorescence microscope, E-PLAN IOS objectives, B&G filtersets.
B-383FL	Trinocular HBO fluorescence microscope, E-PLAN IOS objectives, B&G filtersets.
SZP-FL	HBO fluorescence attachment for SZP stereomicroscope.
B-500TiFL	Trinocular EPI fluorescence microscope, HBO illumination system.
B-1000FL-LED	Trinocular microscope, LED fluorescence.
B-1000FL-HBO	Trinocular microscope, HBO fluorescence.
XDS-2FL	Inverted trinocular EPI fluorescence microscope, HBO illumination system.
XDS-3FL	Inverted trinocular EPI fluorescence microscope, HBO illumination system, with FLUO objectives.
XDS-3FL4	Inverted trinocular EPI fluorescence microscope, HBO illumination system, with quadruple filter holder.

B-383LD2

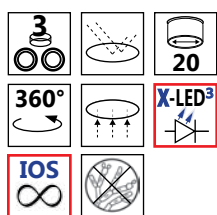

B-1000FL-HBO Model



B-1000FL-HBO

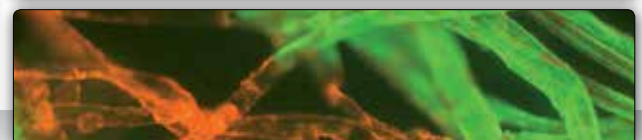
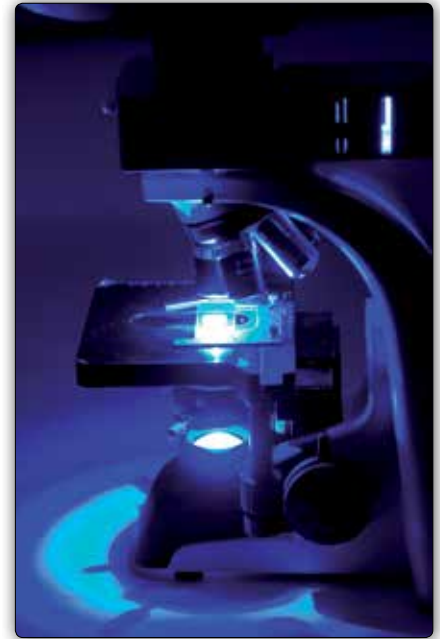
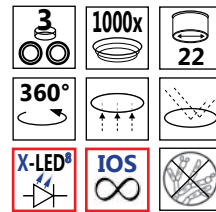

FLUO Series - LED Fluorescence

Imagine a fluorescence microscope that needs a lamp change every 50.000 hours.
Imagine a fluorescence microscope with a cold light source that barely heats up during use.
Imagine a fluorescence microscope that can be switched on, used immediately, switched off and then back on again.
Imagine a fluorescence microscope that is so safe as to need no protection shield whatsoever, and that can be used by everyone, without any specific precaution.
Imagine a fluorescence microscope that can be powered by batteries, as easily as a torchlight.
Imagine a fluorescence microscope that is so sturdy and so compact that it can be used on the field, without any transport problems.
You may think that such an instrument exists in your imagination only.
Actually, such microscope is real, and its name is **OPTIKA B-383LD**.
Developed by the **OPTIKA** Research labs, the **B-383LD** marks a revolution in the field of fluorescence microscopy. Strictly derived from the **B-383FL** model, of which it shares the body, the optics and the filter sets, the **B-383LD** employs high-power **LED** instead of the classical mercury vapour bulb.
The **LED** is tailored to the specific applications (FITC-TRITC).
The brightfield illuminator uses our **X-LED™** system, and the colour temperature closely matches sunlight. The microscope is available in two versions: **B-383LD1** and **B-383LD2**.

B-383LD1 Model - Technical specifications

Part	Description
Head	Trinocular, 30° inclined, 360° rotating. Interpupillary adjustment 48-75 mm.
Eyepieces	WF10X/20mm
Nosepiece	5 position on reversed revolving nosepiece. Ball bearing rotation.
Objectives	IOS E-PLAN 4x/0.10, 10x/0.25, 20x/0.40, 40x/0.65, and PLAN 50x/0.75 (no cover slide).
Focusing system	Coaxial coarse and fine.
Stage	Double layer mechanical sliding stage, dimensions 216x150mm, moving range 78x54mm. Belt-drive in X direction.
Condenser	Abbe condenser, sliding-in, N.A. 1.25 with centering system.
Illumination	Transmitted light: X-LED ³ , with manual brightness control. Epi-fluorescence: high-power blue LED
Power supply	External power supply: Input 100-240Vac 50-60Hz / Output 6Vdc 1A

Standard filterset

Name	Excitation filter (nm)	Dichroic mirror cut-off (nm)	Emission filter (nm)
B (Blue)	460 – 490	505	515LP

B-383LD2 Model

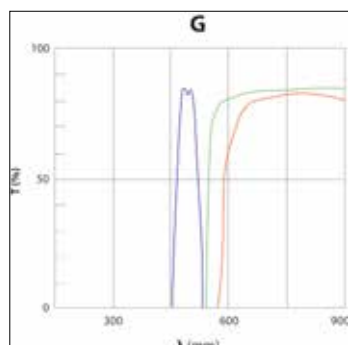
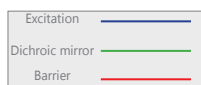
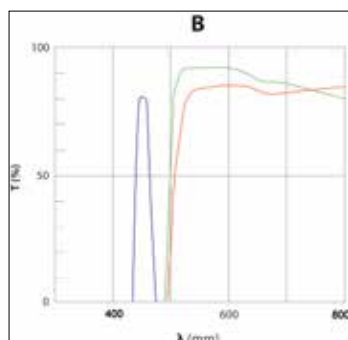

B-383LD2

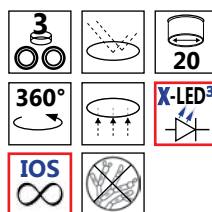

B-383LD2 Model - Technical specifications

Part	Description
Head	Trinocular, 30° inclined, 360° rotating. Interpupillary adjustment 48-75 mm.
Eyepieces	WF10X/20mm
Nosepiece	5-position reversed revolving nosepiece. Ball bearing rotation.
Objectives	IOS E-PLAN 4x/0.10, 10x/0.25, 20x/0.40, 40x/0.65, and PLAN 50x/0.75 (no cover slide).
Focusing system	Coaxial coarse and fine.
Stage	Double layer mechanical sliding stage, dimensions 216x150mm, moving range 78x54mm. Belt-drive in X direction.
Condenser	Abbe condenser, sliding-in, N.A. 1.25 with centering system.
Illumination	Transmitted light: X-LED ³ , with manual brightness control. Epi-fluorescence: high-power white LED (for B and G filtersets)
Power supply	External power supply: Input 100-240Vac 50-60Hz / Output 6Vdc 1A

Standard filterset

Name	Excitation filter (nm)	Dichroic mirror cut-off (nm)	Emission filter (nm)
B (Blue)	460 – 490	505	515LP
G (Green)	510 – 550	570	590LP

B-383FL Model

B-383FL

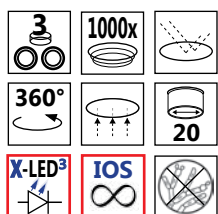

B-383FL Model - Technical specifications

Part	Description
Head	Trinocular, 30° inclined, 360° rotating. Interpupillary adjustment 48-75 mm.
Eyepieces	WF10X/20mm
Nosepiece	5-position reversed revolving nosepiece. Ball bearing rotation.
Objectives	IOS E-PLAN 4x/0.10, 10x/0.25, 20x/0.40, 40x/0.65, 100x/1.25 (oil)
Focusing system	Coaxial coarse and fine.
Stage	Double layer mechanical sliding stage, dimensions 216x150mm, moving range 78x54mm. Belt-drive in X direction.
Condenser	Abbe condenser, sliding-in, N.A. 1.25 with centering system.
Illumination	Transmitted light: X-LED3, with manual brightness control. Epi-fluorescence: HBO 100W high pressure mercury bulb
Power supply	External power supply: Input 100-240Vac 50-60Hz / Output 6Vdc 1A Fluorescence Power Supply 100W. Timer and current display.

Standard filterset

Name	Excitation filter (nm)	Dichroic mirror cut-off (nm)	Emission filter (nm)
B (Blue)	450 - 480	500	515LP
G (Green)	510 - 550	570	590LP

SZP-FL Attachment

SZP-FL



Part	Description
Description	Fluorescence attachment for SZP stereomicroscopes. Fluorescence observation for biology, industrial inspection, criminal justice, etc. Essential tool for security printing and mineral research.
Filterset	Standard: GFP-B (EX460-500, DM505, BA510-560) GFP-L (EX460-500, DM505, BA510)
Illumination	100W HBO high-pressure mercury vapor bulb. Average lamp lifetime: 400 hours. Input voltage: 110/240Vac, 50/60Hz, 1A ; Fuse: F8AL 250V. Maximum input power: 125W. Current and time counter LED displays.
Photo&Video Attachment	Trinocular output port

B-500TiFL Model - Technical specifications

Part	Description
Optical system	Mechanical tube length: IOS - Infinity Optical System; parfocal distance 45 mm.
Head	Trinocular, 30° inclined, 360° rotating. Diopter adjustment; interpupillary distance adjustment 55-75 mm.
Eyepieces	Wide Field 10x/22 mm.
Nosepiece	5-position reversed revolving nosepiece. Ball bearing linear guides.
Objectives	IOS Planachromatic FLUO 4x/0.13, 10x/0.30, 20x/0.50, 40x/0.75
Specimen stage	Double layer with mechanical sliding stage, 175x145 mm; moving range 76x51 mm.
Focusing system	Rack and pinion mechanism, with coaxial coarse and fine control knobs. Fine adjustment graduation 0.002 mm. Vertical movement range: 20 mm. Tension control on right side; upper stage drive stop on left side.
Condenser	Centrable Abbe condenser (swing-out type) with double lens. N.A. 0.9 Fitted with iris diaphragm. Height adjustment by a rack and pinion mechanism.
Transmitted illumination	X-LED ³ illumination system.
Incident illumination	HBO 100W high pressure mercury bulb for epi-fluorescence.

Standard filters (included)

Name	Excitation wavelength (nm)	Dichroic mirror cut-off (nm)	Barrier filter cut-off (nm)
B (Blue)	450-490	495	500-550
G (Green)	540-580	585	607-683

Additional filters (as option)

Name	Excitation wavelength (nm)	Dichroic mirror cut-off (nm)	Barrier filter cut-off (nm)
V (Violet)	390-420	440	450LP
UV	325-375	415	435LP

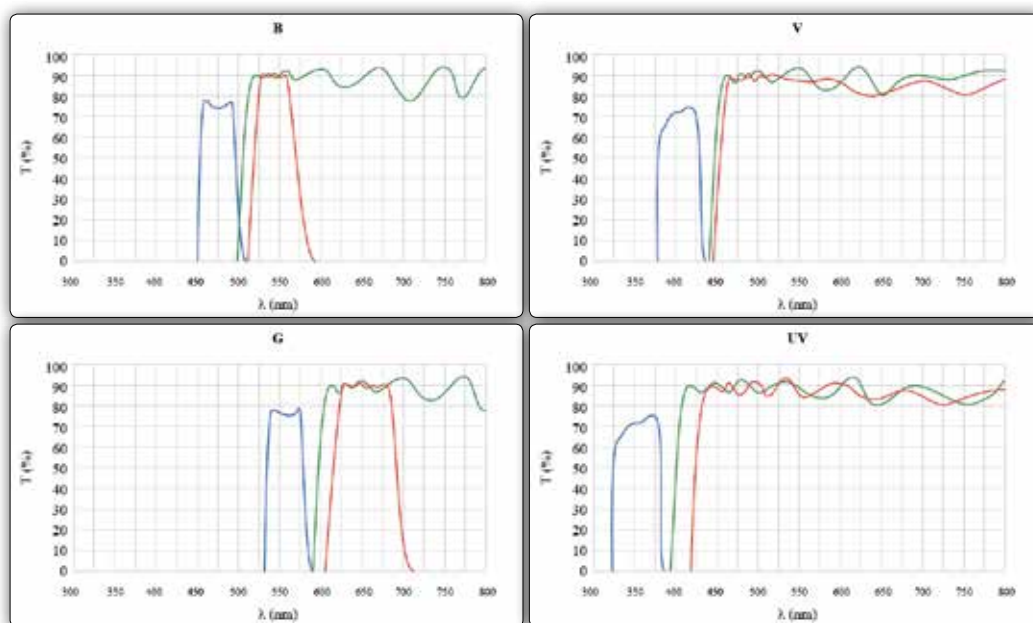

**MANY MORE FILTERSETS
AVAILABLE ON REQUEST**

FLUO Series - HBO Fluorescence

B-500TiFL

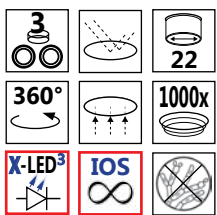

HB100W high-pressure mercury bulb for fluorescence

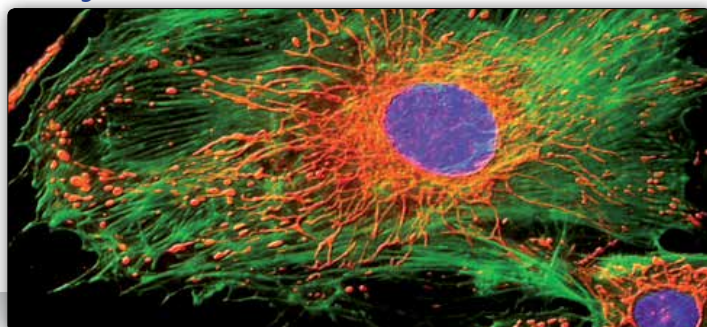
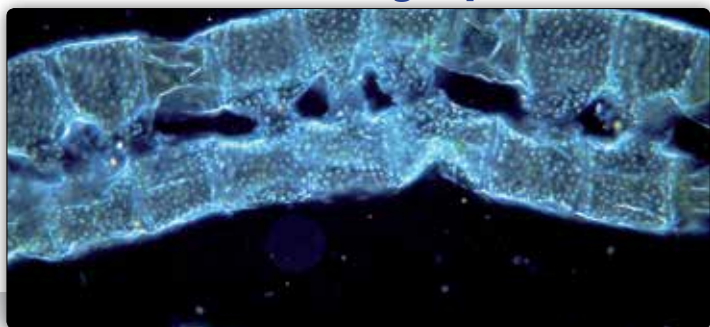

B-1000FL-LED Model



B-1000FL-LED

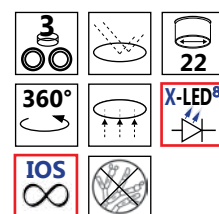

B-1000FL-LED

Type:

LED FLUORESCENCE RESEARCH MICROSCOPE

Description:

Laboratory microscope for routine and research applications.

Dye-cast frame, with high stability and ergonomy, for transmitted and incident light observation.



Version for LED epifluorescence analysis.

Transmitted illumination: X-LED[®] (8W power).

Epi-illumination: special attachment with built-in high-power colored LEDs.

Standard filtersets (included)

Name	Excitation wavelength (nm)	Dichroic mirror cut-off (nm)	Barrier filter wavelength (nm)
B (Blue)	450-490	495	520LP
G (Green)	500-540	565	575LP

B-1000FL-LED Model - Configuration chart

BUILD THE MICROSCOPE THAT SUITES YOUR NEEDS BY CHOOSING AMONG THE COMPONENTS OF CONFIGURATION CHART:

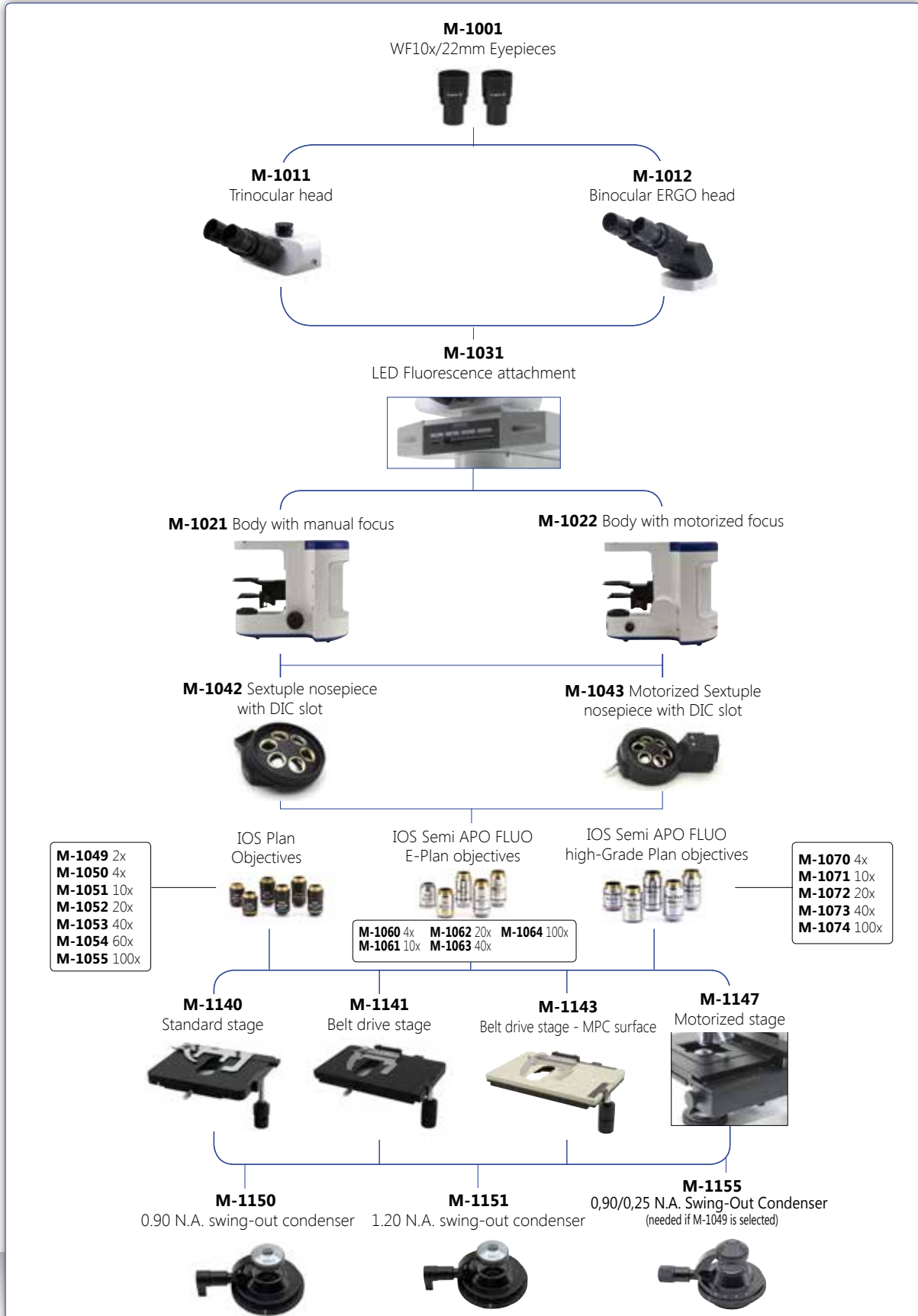

B-1000FL-HBO Model



B-1000FL-HBO

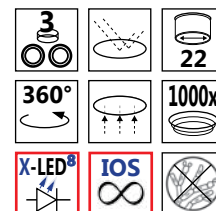

B-1000FL-HBO

Type:

FLUORESCENCE RESEARCH MICROSCOPE

Description:

Laboratory microscope for routine and research applications.

Dye-cast frame, with high stability and ergonomoy, for transmitted and incident light observation.



Version for epifluorescence analysis.

Transmitted illumination: X-LED[®] (8W power).

Epi-illumination: special attachment with 100W mercury lamp and 6-position filter wheel.

Standard filtersets (included)

Name	Excitation wavelength (nm)	Dichroic mirror cut-off (nm)	Barrier filter wavelength (nm)
B (Blue)	460-490	500	520LP
G (Green)	510-550	570	590LP

Additional filters (as option)

Name	Excitation wavelength (nm)	Dichroic mirror cut-off (nm)	Barrier filter wavelength (nm)
V (Violet)	400-410	455	455LP
UV	330-385	400	420LP

B-1000FL-HBO Model - Configuration chart

BUILD THE MICROSCOPE THAT SUITES YOUR NEEDS BY CHOOSING AMONG THE COMPONENTS OF CONFIGURATION CHART:

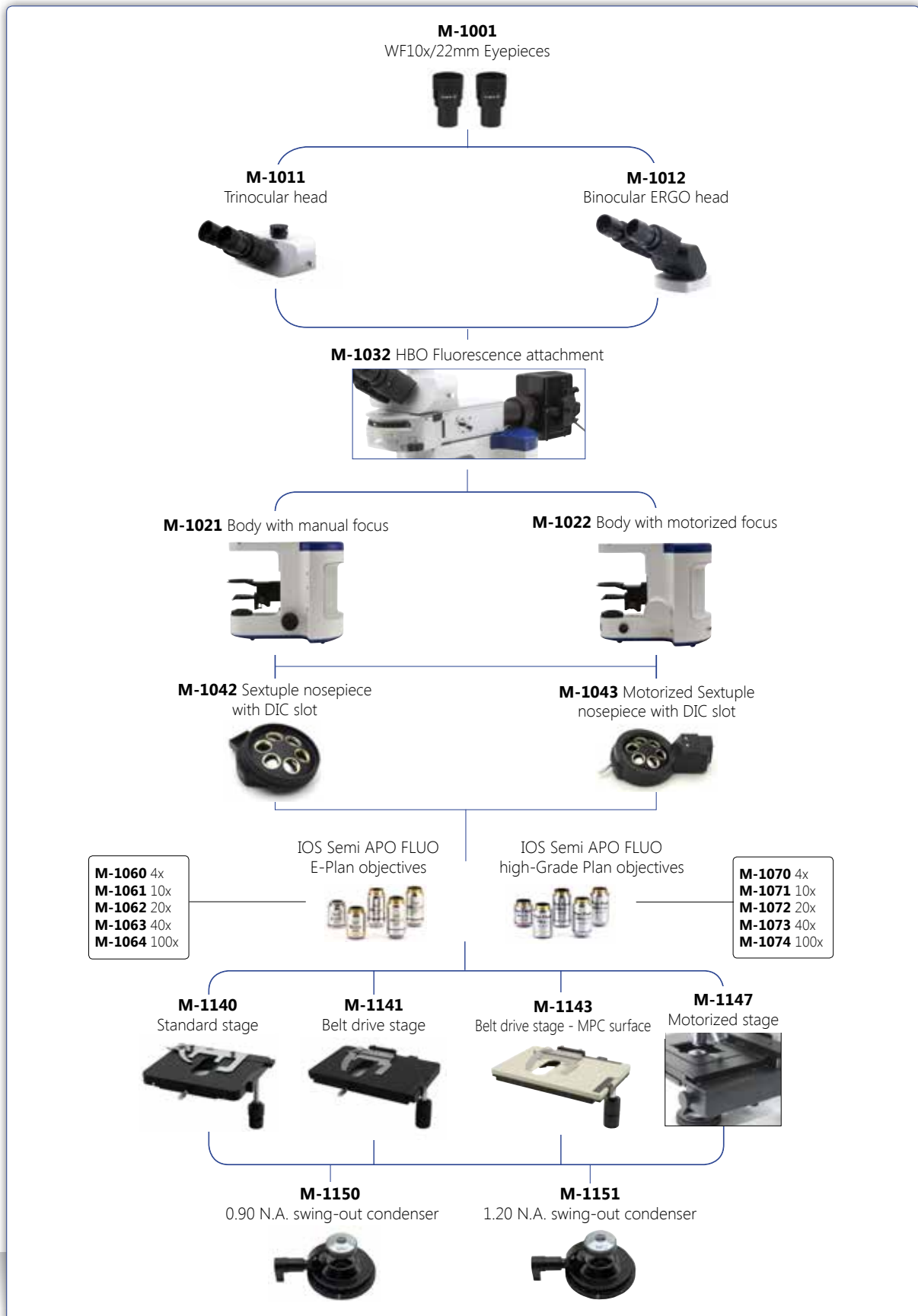

XDS-2FL Model

The instrument

XDS-2FL is a routine inverted epifluorescence microscope. The basic structure is dedicated to the most demanding applications of routine fluorescence analysis. XDS-2FL offers, in the same unit, brightfield and phase contrast capabilities, thus extending its potentials to most multi-contrast applications.

Optical system

The epifluorescence optical system is implemented via the standard excitation filter-dichroic mirror-barrier filter combination, applied to a 100W Hg lamp. It is supplied with EWF10x/22mm extra-widefield eyepieces, long working distance IOS objectives, and a double filterblock set (blue and green excitation).

The extensive range of optional accessories allows a quick interchange of contrast mechanisms and a multi-contrast observation without removal of the specimen from the stage.

User comfort

XDS-2 is comfortable for the operator. The 22 mm extra-wide field is pleasant to use and minimizes operator stress. The special eyepieces are designed for eyeglass wearers.

Ergonomy

Every control is easy to reach, every component has been designed for a comfortable use. The focusing and specimen translation controls are designed to allow to rest the wrists on the table. The brightfield light intensity regulation is placed very close to the focusing knobs. The specimen stage is fitted with a special glass insert that allows to see the objectives, for immediate identification of the magnification setup. The head implements an extremely innovative design, that permits adjustment to compensate for operator height.

XDS-2FL

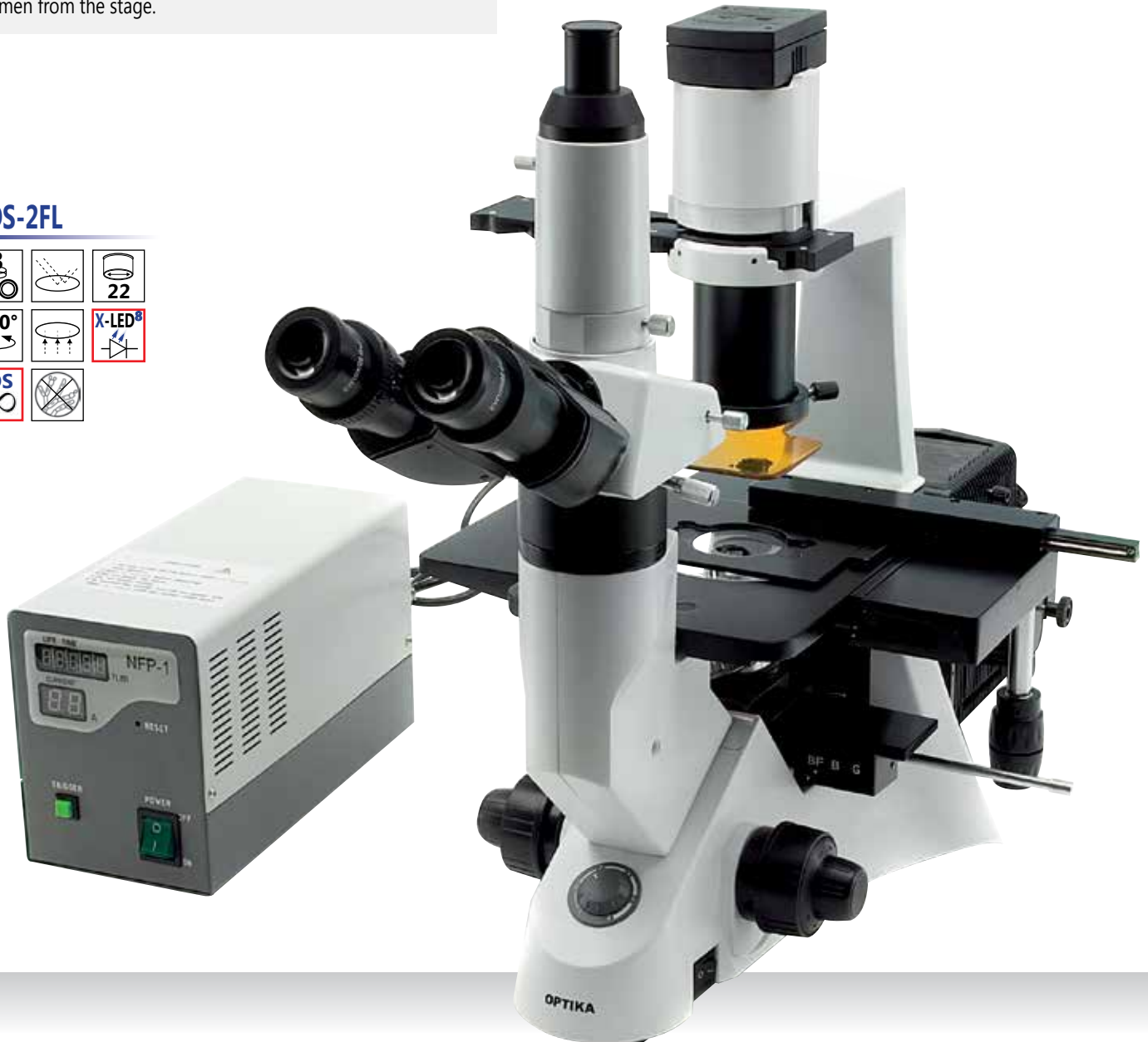
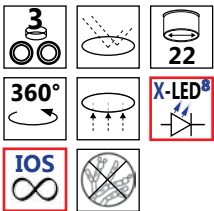

XDS-2FL Model - Technical specifications

Part	Description
Optical system	Infinity corrected system, 45 mm parfocality distance. Field number 22 mm.
Head	Trinocular: 30° inclined, 360° rotating. Interpupillary distance: 48 - 75 mm. Adjustable dioptric compensation. Ergonomical head available as option.
Eyepieces	Extra-wide field 10x/22mm, High-point.
Nosepiece	5 positions, with bidirectional rotation on ball bearings and click stop.
Objectives	Long working distance (LWD) infinity corrected (IOS) planachromatic: 4x/0.10 (working distance 18 mm), 10x/0.25 with phase ring (working distance 10 mm), 20x/0.40 with phase ring (working distance 5.1 mm), 40x/0.60 (working distance 2.6 mm). Corrected for 1.2 mm coverglass.
Specimen stage	Size: 250 x 230 mm. Translator with lowered ergonomic coaxial controls. X-Y translation: 119 x 70 mm. Interchangeable metallic inserts for specimen slides, Petri dishes and flasks.
Focusing system	Macro and micrometric regulation, with coaxial knobs on both sides of the stand. Adjustable tension.
Condenser	Long working distance condenser, numerical aperture 0.30, working distance 72 mm. The condenser can be removed in order to increase the working distance to 150 mm.
Illumination	X-LED8 system precentered illuminator, with adjustable intensity, filter and phase ring holder and aperture diaphragm. Inverted epifluorescence: HBO 100W high pressure mercury bulb, knobs for lamp and back mirror alignment.
Filtersets	Blue and Green fluorescence filtersets. No other as option.

		Excitation	Dichroic Mirror	Barrier Filter
Filter sets	Blue excitation	BP460-490	DM500	520LP
	Green excitation	BP480-550	DM570	590LP

STANDARD FILTERS

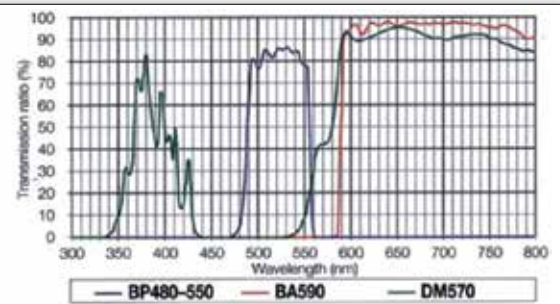
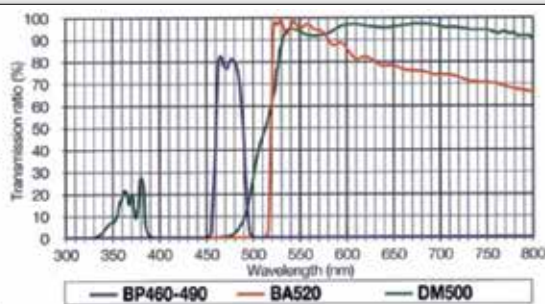

XDS-3FL & XDS-3FL4 Model

The instrument

XDS-3FL is an advanced inverted epifluorescence microscope. Thanks to its special FLUO objectives, designed with quartz and special glasses (low in auto-fluorescence), XDS-3FL is upgradable with every kind of fluorescence filterset. The instrument offers, in the same unit, bright-field and phase contrast capabilities, thus extending its potentials to most multi-contrast applications.

Optical system

The epifluorescence optical system is implemented via the standard excitation filter-dichroic mirror-barrier filter combination, applied to a 100W Hg lamp. It is supplied with EWF10x/22mm extra-widefield eyepieces, long working distance IOS FLUO objectives, and a double filterblock set (blue and green excitation as standard configuration). The extensive range of optional accessories allows a quick interchange of contrast mechanisms, and multi-contrast observation without removal of the specimen from the stage.

Ergonomy

Every control is easy to reach, every component has been designed for comfortable use. The focusing and specimen translation controls are designed to allow to rest the wrists on the table.

The brightfield light intensity regulation is placed very close to the focusing knobs.

The specimen stage is fitted with a special glass insert, that allows to see the objectives, for immediate identification of the magnification setup.

User comfort

XDS-3FL is comfortable for the operator.

The 22 mm extra-wide field is pleasant to use and minimizes operator stress.

The special eyepieces are designed for eyeglass wearers.

XDS-3FL/XDS-3FL4

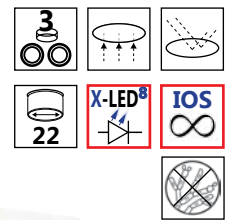

**MANY MORE FILTERSETS
AVAILABLE ON REQUEST**

XDS-3FL & XDS-3FL4 Model - Technical specification

Part	Description
Optical system	Infinity corrected system, 45 mm parfocality distance. Field number 22 mm.
Head	Trinocular: 45° inclined. Interpupillary distance: 48 - 75 mm. Adjustable dioptric compensation.
Eyepieces	Extra-wide field 10x/22mm, High-point.
Nosepiece	5 positions, with bidirectional rotation on ball bearings and click stop.
Objectives	Long working distance (LWD) infinity corrected (IOS) planachromatic: FLUO 10X/0.3 (working distance 10 mm), FLUO 20X/0.45 (working distance 5.1 mm), FLUO 40X/0.65 (working distance 2.6 mm). Corrected for 1.2 mm coverglass.
Specimen stage	Size: 250 x 230 mm. Translator with lowered ergonomic coaxial controls. X-Y translation: 120x80 mm. Interchangeable metallic inserts for specimen slides, Petri dishes and flasks.
Focusing system	Macro- and micrometric regulation, with coaxial knobs on both sides of the stand. Adjustable tension.
Condenser	Long working distance condenser, numerical aperture 0.30, working distance 72 mm. The condenser can be removed in order to increase the working distance to 150 mm. Green IF550 filter and Blue LBD filter are provided.
Illumination	Brightfield: X-LED ⁸ system, precentered illuminator, with adjustable intensity and aperture diaphragm. Epi-fluorescence: HBO 100W high pressure mercury bulb, knobs for lamp alignment.
Filtersets	Blue and Green fluorescence filtersets. Violet and Ultraviolet as optional accessories. XDS-3FL4 - Same as XDS-3FL with 4 positions filter holder (Blue and Green filtersets, plus 2 empty positions).

Filter sets	Excitation	Dichroic Mirror	Barrier Filter
Blue excitation	BP460-490	DM500	520LP
Green excitation	BP480-550	DM570	590LP
Ultraviolet excitation	BP325-375	DM400	420LP
Violet excitation	BP385-425	DM440	455LP

STANDARD FILTERS

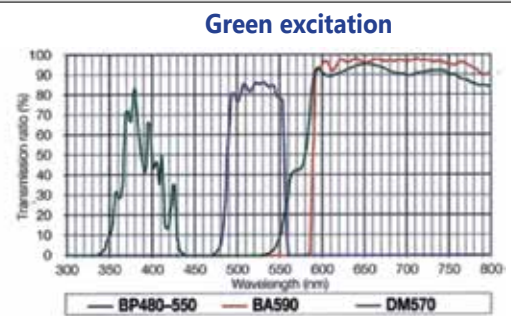
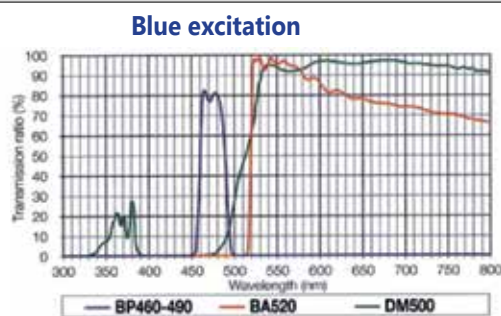

OPTIONAL FILTERS

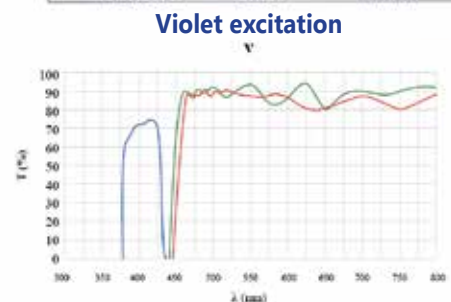
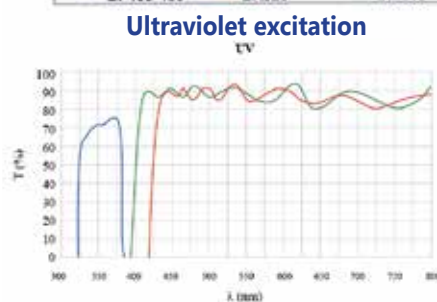

FLUO Series - Accessories

Accessories for B-383LD1 / B-383LD2 / B-383FL

M-160	Eyepiece WF10x/20mm.
M-161	Eyepiece EW15x/16mm.
M-162	Eyepiece WF20x/10mm.
M-163	Micrometer eyepiece WF10x/20mm.
M-005	Micrometric slide 26x76 mm, range 1 mm, div. 0,01 mm.
M-144	Objective 4x/0,10 IOS E-PLAN.
M-145	Objective 10x/0,25 IOS E-PLAN.
M-146	Objective 20x/0,40 IOS E-PLAN.
M-147	Objective 40x/0,65 IOS E-PLAN.
M-335	Objective 50x/0,75 IOS PLAN MET.
M-149	Objective 60x/0,80 IOS E-PLAN.
M-148	Objective 100x/1,25 IOS E-PLAN (Oil).
M-181	Complete Phase Contrast Set with IOS PLAN obj. 10x, 20x, 40x, 100x, with Darkfield position
M-174.1	Polarizing set, filters only (for B-380 series).
M-175	Rotating table for polarizing set.
M-185	Darkfield condenser for dry objectives.
M-173	Photo adapter for APS-C and Full Frame Reflex cameras.
M-114	C-Mount adapter for 1/2" sensor.
M-116	C-Mount adapter for 2/3" sensor.
M-069	Solar battery pack.
M-151	HBO100W high-pressure mercury bulb for fluoresc. (for B-383FL only).

Accessories for B-500TiFL

M-680	Ergo binocular head 30°-60°.
M-780	Eyepiece EWF10x/22mm.
M-601	Eyepiece WF15x/16mm.
M-781	Eyepiece micrometer EWF10x/22mm.
M-005	26x76 mm micrometric slide. Range 1 mm, div. 0,01 mm.
M-760	Objective IOS PLAN Achromatic for phase contrast 10x/0,25.
M-761	Objective IOS PLAN Achromatic for phase contrast 20x/0,40.
M-762	Objective IOS PLAN Achromatic for phase contrast 40x/0,65.
M-763	Objective IOS PLAN Achromatic for phase contrast 100x/1,25 (Oil).
M-681	Objective IOS FLUOR PLAN Achromatic 4x/0,13.
M-682	Objective IOS FLUOR PLAN Achromatic 10x/0,30.
M-683	Objective IOS FLUOR PLAN Achromatic 20x/0,50.
M-684	Objective IOS FLUOR PLAN Achromatic 40x/0,75.
M-685	Objective IOS FLUOR PLAN Achromatic 100x/1,30.
M-613	Polarising set (Polarizer and Analyzer filters).
M-615	Lambda filter for polarising set.
M-614	Rotating table for polarising set.
M-618	Darkfield condenser for dry objectives.
M-617	Complete phase contrast set with plan IOS obj. 10x, 20x, 40x, 100x.
M-666	Heating stage, with digital temperature controller (only for biological microscopes).
M-619	Photo adapter for REFLEX camera with FULL FRAME sensor.
M-699	Universal adapter for M-114, M-116, M-173 and eyepiece cameras.
M-620	Focusable C-Mount adapter for 1/3" sensor.
M-620.1	Focusable C-Mount adapter for 1/2" sensor.
M-620.2	Focusable C-Mount adapter for 2/3" sensor.
M-151	HBO100W high-pressure mercury bulb for fluorescence.
M-670	Empty fluorescence filterblock for B-500TiFL.
M-671	Fluorescence filterset (filterblock included) V for B-500TiFL.
M-672	Fluorescence filterset (filterblock included) UV-DAPI for B-500TiFL.
M-034	Dust cover type 5.
M-975	Blue filter, 45 mm diameter.
M-977	Green filter, 45 mm diameter.
M-979	Yellow filter, 45 mm diameter.
M-989	Frosted glass filter, 45 mm diameter.
M-690	Eyecup (pair).
M-173	Photo adapter for APS-C and Full Frame Reflex cameras.
M-114	C-Mount adapter for 1/2" sensor.
M-116	C-Mount adapter for 2/3" sensor.

Accessories for XDS-2FL

M-755	Ergonomical binocular head.
M-755.1	Trinocular attachment for Ergonomical binocular head (M-755).
M-017	Eyepiece EWF10x/22mm.
M-021	Eyepiece micrometer EWF10x/22mm.
M-005	26x76 mm micrometric slide. Range 1 mm, div. 0,01 mm.
M-173	Photo adapter for APS-C and Full Frame Reflex cameras.
M-770	Objective IOS LWD PLAN Achromatic 4x/0,10 (w.d. 18mm)

M-771	Objective IOS LWD PLAN Achromatic for phase contrast 10x/0,25 (w.d. 10mm).
M-772	Objective IOS LWD PLAN Achromatic for phase contrast 20x/0,40 (w.d. 5,1mm).
M-773	Objective IOS LWD PLAN Achromatic 40x/0,60 (w.d. 2,6mm).
M-774	Objective IOS LWD PLAN Achromatic for phase contrast 40x/0,60 (to use with M-776).
M-776	Phase ring 40x (to use with M-774).
M-151	HBO100W high-pressure mercury bulb for fluorescence.
M-778	C-mount adapter for 1/3", 1/2" and 2/3" sensor.
M-036	Dust cover type 7.
M-173	Photo adapter for APS-C and Full Frame Reflex cameras.
M-114	C-Mount adapter for 1/2" sensor.
M-116	C-Mount adapter for 2/3" sensor.

Accessories for XDS-3FL/XDS-3FL4

M-780	Eyepiece EWF10x/22mm.
M-781	Eyepiece micrometer EWF10x/22mm.
M-005	26x76 mm micrometric slide. Range 1 mm, div. 0,01 mm.
M-782	Objective IOS LWD PLAN Achromatic 4x/0,10 (w.d. 22mm).
M-782.1	Objective IOS LWD PLAN Achromatic for phase contrast 4x/0,13 (w.d. 16,9mm)
M-783N	Objective IOS LWD PLAN Achromatic for phase contrast 10x/0,25 (w.d. 7,94mm).
M-784N	Objective IOS LWD PLAN Achromatic for phase contrast 20x/0,40 (w.d. 7,66mm).
M-785	Objective IOS LWD PLAN Achromatic for phase contrast 40x/0,60 (w.d.3,71mm).
M-783.1N	Mounted phase ring for 4x/10x (for XDS-3FL series).
M-785.1N	Mounted phase ring for 20x/40x (for XDS-3FL series).
M-786	Objective IOS LWD PLAN Achromatic 60x/0,70 (w.d. 2,50mm).
M-801	Objective IOS LWD FLUOR PLAN Achromatic 10x/0,25 (w.d. 10mm).
M-802	Objective IOS LWD FLUOR PLAN Achromatic 20x/0,40 (w.d. 5,1mm).
M-803	Objective IOS LWD FLUOR PLAN Achromatic 40x/0,60 (w.d. 2,6mm).
M-804	Objective IOS LWD FLUOR PLAN Achromatic 60x/0,7.
M-676	Empty fluorescence filterblock (for XDS-3FL series).
M-677	Fluorescence filterset (filterblock included) V (for XDS-3FL series).
M-678	Fluorescence filterset (filterblock included) UV-DAPI (for XDS-3FL series).
M-151	HBO100W high-pressure mercury bulb for fluorescence.
M-787	Cut-off filter (infrared).
M-788	Photo adapter for REFLEX camera with FULL FRAME sensor.
M-789	Focusable C-Mount adapter for 1/3" sensor.
M-789.1	Focusable C-Mount adapter for 1/2" sensor.
M-789.2	Focusable C-Mount adapter for 2/3" sensor.
M-699	Universal adapter for M-114, M-116, M-173 and eyepiece cameras
M-036	Dust cover type 7.
M-679	Empty filter block 4 positions (only for XDS-3FL).
M-677.1	Fluorescence filterset V for XDS-3FL4.
M-678.1	Fluorescence filterset UV-DAPI for XDS-3FL4.
M-173	Photo adapter for APS-C and Full Frame Reflex cameras.
M-114	C-Mount adapter for 1/2" sensor.
M-116	C-Mount adapter for 2/3" sensor.

Accessories for B-1000FL-LED / B-1000FL-HBO

M-005	Micrometric slide, 26x76mm, range 1mm, div. 0,01mm
M-613	Polarizing set (Polarizer and Analyzer filters).
M-615	Lambda filter for polarizing set.
M-617.1N	Phase contrast set with IOS PLAN objective 40x.
M-690	Eyecup (pair).
M-619	Photo tube adapter for full frame SLR camera.
M-173	Photo adapter for APS-C and Full Frame Reflex cameras.
M-620	Focusable C-Mount adapter for 1/3" sensor.
M-620.1	Focusable C-Mount adapter for 1/2" sensor.
M-620.2	Focusable C-Mount adapter for 2/3" sensor.
M-151	HBO 100W high-pressure mercurybulb for fluorescence.
M-1164	Empty fluorescence filterblock for B-1000FL-HBO.
M-1165	Fluorescence filterset V (filterblock included) for B-1000FL-HBO.
M-1166	Fluorescence filterset UV-DAPI (filterblock included) for B-1000FL-HBO.
M-699	Universal adapter for M-114, M-116, M-173 and eyepiece cameras
M-114	C-Mount adapter for 1/2" sensor.
M-116	C-Mount adapter for 2/3" sensor.
M-113.1	Ring adapter, 30mm (for monocular and binocular microscopes).
M-ND25	Neutral density filter ND25 (for B-1000FL-HBO).
15008	OPTIKA immersion oil, 10ml.



How to connect the cameras to our microscopes.

Please refer to the Adapter reference list on Digital section.

XDS Series

Inverted biological microscopes



XDS Series

A complete range of microscopes, designed to meet your laboratory needs.

Quality, innovative technology, power, safety and simplicity of use are the common characteristics of these instruments.

- XDS-2** Trinocular Inverted microscope, IOS LWD Objectives, X-LED illumination.
- XDS-2ERGO** Trinocular Inverted microscope with ERGO head, IOS LWD Objectives, X-LED illumination.
- XDS-3** Trinocular Inverted microscope, IOS LWD Objectives, X-LED ill. (with mechanical stage and aluminium box).
- XDS-3LT** Trinocular Inverted microscope, IOS LWD Objectives, X-LED ill. (without mechanical stage and aluminium box).

XDS-3

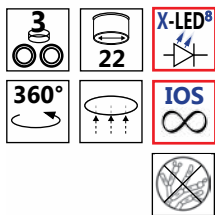

XDS Series

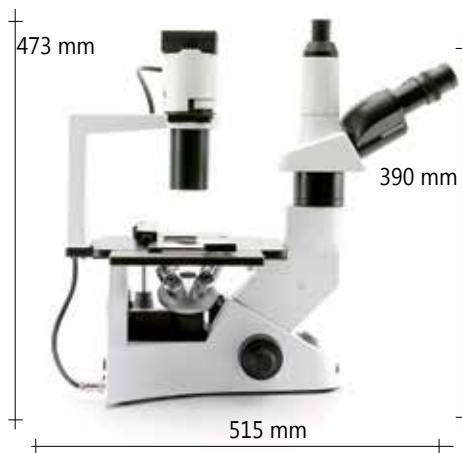
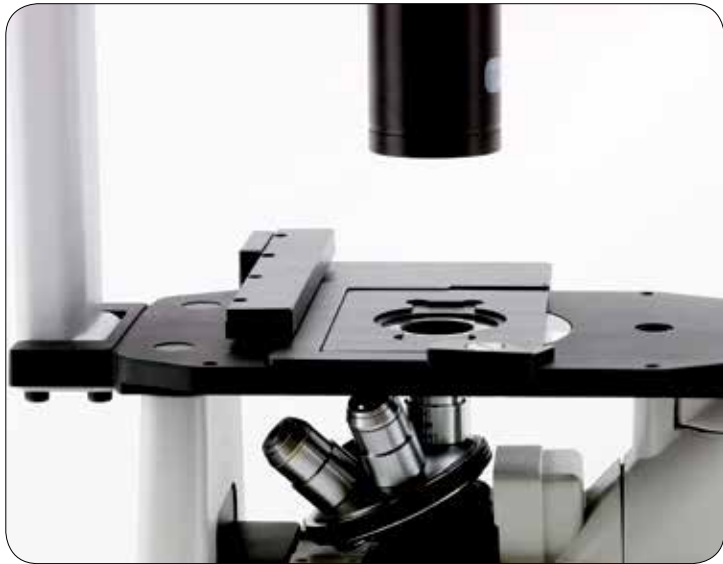
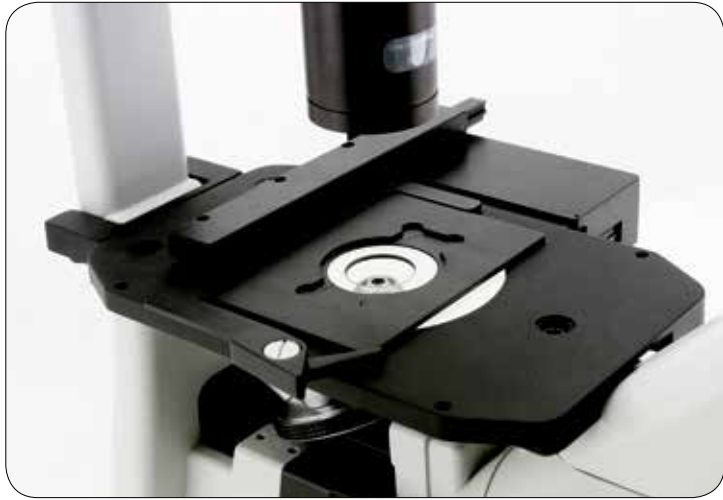

XDS-2



XDS-3

XDS-2 Model

All included, in the right place: this is the philosophy underlying this instrument.

XDS-2 is equipped with a full series of objectives, that covers most standard applications.

The translating stage is included in the standard equipment, and so is a set of 4 objectives (4x and 40x for brightfield; 10X and 20X for phase contrast).

A complete solution for your brightfield observation

Ergonomy

Every control is easy to reach, every component has been designed with ease of use in mind.

The focusing and specimen translation controls are designed to allow to rest the wrists on the table.

The light intensity adjustment is placed very close to the focusing knobs.

The specimen stage is fitted with a special glass insert, that allows to see the objectives, for immediate identification of the magnification setup.

The head implements an extremely innovative design, that permits adjustment to compensate for operator height.

Efficiency

Plan-achromatic infinity corrected optics, bright 8W LED illuminator, phase contrast set, holders for specimen slides, flasks, Petri dishes, trinocular head for photo/video applications. These are the features of XDS-2, a powerful, complete and innovative instrument, designed to set a reference standard for advanced routine microbiology.

User comfort

XDS-2 is comfortable for the operator. The 22 mm extra-wide field is pleasant to use, and minimizes operator stress.

The special eyepieces are designed for eyeglass wearers.

XDS-2



XDS-2 and XDS-2ERGO Models - Technical specifications

Part	Description
Optical system	Infinity corrected system, 45 mm parfocality distance. Field number 22 mm.
Head	XDS-2: Trinocular: 30° inclined, 360° rotating. Interpupillary distance: 48 - 75 mm. Adjustable dioptic compensation. Ergonomic height compensation. XDS-2ERGO: 0°-30° ergonomical head with side photo tube.
Eyepieces	Extra-wide field 10x/22mm, high-point.
Nosepiece	5 positions, with bidirectional rotation on ball bearings and click stop.
Objectives	Long working distance (LWD) infinity corrected (IOS) planachromatic: 4x/0.10 (working distance 18 mm), phase contrast 10x/0.25 (working distance 10 mm), phase contrast 20x/0.40 (working distance 5.1 mm), 40x/0.60 (working distance 2.6 mm), corrected for 1.2 mm coverglass.
Specimen stage	Size: 250 x 230 mm. Translator with lowered ergonomic coaxial controls. X-Y translation: 119 x 70 mm. Interchangeable metallic inserts for specimen slides, Petri dishes and flasks.
Focusing system	Macro and micrometric regulation, with coaxial knobs on both sides of the stand. Adjustable tension.
Condenser	Long working distance condenser, numerical aperture 0.30, working distance 72 mm. The condenser can be removed in order to increase the working distance to 150 mm.
Illumination system	X-LED [®] system, with adjustable intensity, filter and phase ring holder and aperture diaphragm.



XDS-2ERGO

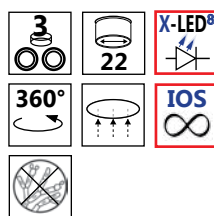

XDS-3 Model

XDS-3 looks at the challenge of the future with confidence, offering first-class completeness, optical quality, mechanical versatility, that open the instrument to all the enhancements and accessories that will be developed throughout the years. OPTIKA has chosen XDS-3 as its inverted microscopy development platform for all illumination and manipulation accessories.

Top level solution for phase contrast observation

Completeness

The multiple access to the optical path ideally complements the infinity-corrected optics, and offers ample freedom for the development of special accessories. The bright 8W LED illuminator, coupled to a full phase ring set, to a photo port, and to the diverse holders for slides, Petri dishes and flasks, qualify XDS-3 as a powerful and complete instrument, that finds its optimal application in high-end routine, and as a complement to the most powerful research microscopes.

Efficiency

Effectiveness does not mean complexity. A particularly simple and ingenious optical design allows stable alignments and smooth and accurate movements throughout years of use. Effectiveness does not mean cost. The optimally targeted design choices, both for mechanics and for optical components, have allowed OPTIKA to reach the performance of XDS-3 without sacrificing the accessibility that characterizes OPTIKA instruments. An additional reason to challenge the future.

Versatility

It still surprises us how, with few well-located controls, a microscope can become so versatile. The controls are located in accessible and comfortable positions, and offer all degrees of freedom necessary for an immediate and pleasant use.

The glass stage surface allows an optimal visual access to the objective turret. The straight neck leaves ample room for sample positioning and for the most advanced probes.

XDS-3

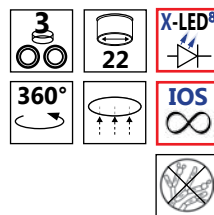

X-LED 8™ vs. Halogen

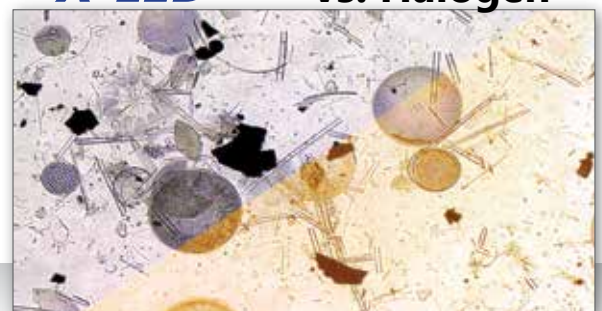

XDS-3 Model - Technical specifications

Part	Description
Optical system	Infinity corrected system, 45 mm parfocality distance. Field of view 22 mm.
Head	Trinocular: 45° inclined. Interpupillary distance: 55 - 75 mm. Adjustable dioptic compensation.
Eyepieces	Extra-wide field 10x/22mm, high-point.
Nosepiece	5 positions, with bidirectional rotation on ball bearings and click stop.
Objectives	Long working distance (LWD) infinity corrected (IOS) planachromatic: phase contrast 10x/0.25 (working distance 7.94 mm), phase contrast 20x/0.40 (working distance 7.66 mm), phase contrast 40x/0.60 (working distance 3.71 mm), corrected for 1.2 mm coverglass.
Specimen stage	XDS-3 Fixed stage: 250 x 230 mm. Translator with lowered ergonomic coaxial controls. X-Y translation: 120x80 mm. XDS-3LT Fixed stage: 250 x 230 mm. Interchangeable metallic inserts for specimen slides, Petri dishes and flasks.
Focusing system	Macro- and micrometric regulation, with coaxial knobs on both sides of the stand. Adjustable tension.
Condenser	Long working distance condenser, numerical aperture 0.30, working distance 72 mm. The condenser can be removed in order to increase the working distance to 150 mm.
Illumination system	X-LED ⁸ system, with adjustable intensity, filter and phase ring holder and aperture diaphragm.



Also available: "LT" version without hard case and moving stage

XDS Series - Accessories

Accessories for XDS-2 / XDS-2ERGO

M-755	Ergonomical binocular head.
M-755.1	Trinocular attachment for Ergonomical binocular head (M-755).
M-017	Eyepiece EWF10x/22mm.
M-021	Eyepiece micrometer EWF10x/22mm.
M-005	26x76 mm micrometric slide. Range 1 mm, div. 0,01 mm.
M-770	Objective IOS LWD PLAN Achromatic 4x/0,10 (w.d. 18mm).
M-771	Objective IOS LWD PLAN Achromatic for phase contrast 10x/0,25 (w.d. 10mm).
M-772	Objective IOS LWD PLAN Achromatic for phase contrast 20x/0,40 (w.d. 5,1mm).
M-773	Objective IOS LWD PLAN Achromatic 40x/0,60 (w.d. 2,6mm).
M-774	Objective IOS LWD PLAN Achromatic for phase contrast 40x/0,60 (to use with M-776).
M-776	Phase ring 40x (to use with M-774).
M-778	C-mount adapter for 1/3", 1/2" and 2/3" sensor.
M-036	Dust cover type 7.
M-795	Fluorescence attachment, HBO100W, B and G filtersets (only for XDS-2).
M-173	Photo adapter for APS-C and Full Frame Reflex cameras.
M-114	C-Mount adapter for 1/2" sensor.
M-116	C-Mount adapter for 2/3" sensor.

Accessories for XDS-3/XDS-3LT

M-780	Eyepiece EWF10x/22mm.
M-781	Eyepiece micrometer EWF10x/22mm.
M-005	26x76 mm micrometric slide. Range 1 mm, div. 0,01 mm.
M-782	Objective IOS LWD PLAN Achromatic 4x/0,10 (w.d. 22mm).
M-782.1	Objective IOS LWD PLAN Achromatic for phase contrast 4x/0.13 (w.d. 16.9mm)
M-783N	Objective IOS LWD PLAN Achromatic for phase contrast 10x/0,25 (w.d. 7,94mm).
M-784N	Objective IOS LWD PLAN Achromatic for phase contrast 20x/0,40 (w.d. 7,66mm).
M-785	Objective IOS LWD PLAN Achromatic for phase contrast 40x/0,60 (w.d. 3,71mm).
M-786	Objective IOS LWD PLAN Achromatic 60x/0,70 (w.d. 2,50mm).
M-787	Cut-off filter (infrared).
M-788	Photo adapter for REFLEX camera with FULL FRAME sensor.
M-789	Focusable C-Mount adapter for 1/3" sensor.
M-789.1	Focusable C-Mount adapter for 1/2" sensor.
M-789.2	Focusable C-Mount adapter for 2/3" sensor.
M-699	Universal adapter for M-114, M-116, M-173 and eyepiece cameras.
M-036	Dust cover type 7.
M-792	Mechanical stage for XDS-3 series, with side extensions.
M-173	Photo adapter for APS-C and Full Frame Reflex cameras.
M-114	C-Mount adapter for 1/2" sensor.
M-116	C-Mount adapter for 2/3" sensor.



How to connect the cameras to our microscopes.

Please refer to the Adapter reference list on Digital section.

15104 - Lens cleaner, 50ml

It cleans glass quickly and effectively, without leaving residue or odor. Ideal for precision lens or prism cleaning.



M-069 - Solar battery pack

Included battery: rechargeable – Lithium-Poly. Capacity: 2600 mAh.
Output voltage: 5,5Vdc.
Dimensions: 120x73x10 mm.
Autonomy: over 6 hours at medium intensity (X-LED³).
Charging modes: with solar panel (12h), with external USB power supply (not included) or from PC USB port (5h).



Headquarters and Manufacturing Facilities

OPTIKA® S.r.l. Via Rigla, 30 - 24010 Ponteranica (BG) - ITALIA - Tel.: +39 035.571.392 - Fax: +39 035.571.435 - info@optikamicroscopes.com

Optika Sales branches

OPTIKA® Spain spain@optikamicroscopes.com

OPTIKA® China china@optikamicroscopes.com

OPTIKA® USA usa@optikamicroscopes.com

OPTIKA® Hungary hungary@optikamicroscopes.com